

0054574  
P0190

**Rammer**  
Stampfer  
Apisonador  
Pilonneuse

**BS 60Y**

**Operator's Manual / Parts Book**  
Betriebsanleitung / Ersatzteile  
Manual de Operación / Lista de Repuestos  
Notice d'Emploi / Liste de Pièces de Rechange



0 0 5 4 5 7 4

WACKER BS60Y

Serial Number: 4144xxxxx, 4160xxxxx, 5013xxxxx, 5838xxxxx,  
5799xxxxx, 6218xxxxx, 6238xxxxx, 6240xxxxx, 6256xxxxx,  
6295xxxxx, 6528xxxxx

TABLE OF CONTENTS

	Page
INSTRUCTIONS FOR ORDERING PARTS . . . . .	.1
SAFETY FIRST . . . . .	.2-3
OPERATION	
Recommended Fuel . . . . .	.5
Before Starting . . . . .	.5
Starting and Stopping . . . . .	.5
Proper Operation . . . . .	.5
PERIODIC MAINTENANCE SCHEDULE . . . . .	.6
MAINTENANCE AND INSPECTION	
Carburetor Adjustments . . . . .	.6-7
Air Cleaner . . . . .	.8
Lubrication . . . . .	.9
Silencer . . . . .	.9
TROUBLESHOOTING . . . . .	.9
TECHNICAL DATA . . . . .	.10
EXPLODED VIEWS AND PARTS LISTS	
Engine Complete . . . . .	.40-43
Carburetor . . . . .	.44-52
Air Filter . . . . .	.53
Starter Complete . . . . .	.54-55
Crankcase . . . . .	.56-57
Guiding Cylinder . . . . .	.58-59
Spring Cylinder . . . . .	.60-61
Guide Handle . . . . .	.62-65
Air Cleaner and Carburetor . . . . .	.66-67
Fuel Tank with In-Tank Fuel Filter . . . . .	.68-69
Decals . . . . .	.70-71
NUMERICAL INDEX . . . . .	.72-74

NOTICE: CALIFORNIA ASSEMBLY BILL 1642 REQUIRES ALL INTERNAL COMBUSTION ENGINES TO BE EQUIPPED WITH SPARK ARRESTORS. THE USER IS SUBJECT TO CRIMINAL AND CIVIL NEGLIGENCE FROM FIRES STARTED BY ENGINES WITHOUT SPARK ARRESTORS.

INSTRUCTIONS FOR ORDERING PARTS

1. On all orders for spare parts, INCLUDE SERIAL NUMBER AND MODEL NUMBER OF THE MACHINE. Shipment will be delayed if this information is not included.
2. The identification plate for the model and serial number is located on the crankcase housing.
3. Be sure to include the correct description and part number.
4. Supply us with exact shipping instructions, including preferred routing and complete destination address.
5. Do not return parts to the factory and/or branch unless you have written permission from the Company. All authorized returns must be shipped pre-paid.

THIS BOOK IS BASED ON INFORMATION AVAILABLE AT THE TIME OF PRINTING AND IS SUBJECT TO REVISION AND CHANGE WITHOUT NOTICE











SAFETY FIRST













READ, UNDERSTAND, AND FOLLOW THESE SAFETY GUIDELINES TO AVOID DAMAGE TO RAMMER, OPERATOR INJURY, OR DEATH

**WARNING: EAR PROTECTION IS REQUIRED WHEN OPERATING THIS RAMMER**

GASOLINE AND DIESEL FUELS ARE FLAMMABLE. UNSAFE HANDLING WILL CAUSE PERSONAL INJURY AND PERHAPS DEATH.

-  DO NOT smoke while operating rammer.
-  DO NOT smoke when refueling engine.
-  DO NOT refuel hot or running engine.
-  DO NOT refuel engine near open flame.
-  DO NOT spill fuel when refueling engine.
-  DO NOT operate rammer near open flames.
-  ALWAYS refill fuel tank in well-ventilated area.
-  ALWAYS replace fuel tank cap after refueling.

A RAMMER OPERATED IMPROPERLY OR BY UNTRAINED PERSONNEL IS DANGEROUS. DAMAGE TO RAMMER, INJURY TO OPERATOR AND BYSTANDERS IS POSSIBLE.







-  DO NOT use rammer in applications for which it is not intended.
-  DO NOT allow improperly trained personnel to operate rammer.
-  DO NOT use choke to stop engine.
-  DO NOT touch hot muffler, engine cylinders, or cooling fins. Burns will result.
-  DO NOT use accessories or attachments which are not recommended by contractor for rammer. Damage to rammer and/or injury to user may result.
-  ALWAYS read, understand, and follow Instruction Book procedures before attempting to operate equipment.
-  ALWAYS be sure operator is familiar with proper safety precautions and operation techniques before using rammer.
-  ALWAYS wear protective clothing when operating rammer. Goggles or safety glasses will protect against eye damage caused by flying debris, for instance.
-  ALWAYS keep hands, feet, and loose clothing away from moving parts of rammer.
-  ALWAYS use common sense and caution when operating rammer.







SAFETY FIRST







SAFETY DEVICES AND GUARDS ARE DESIGNED WITH OPERATOR SAFETY IN MIND. THEY ARE INTENDED TO PROTECT OPERATOR FROM MOVING PARTS AND OTHER POTENTIAL SAFETY HAZARDS. DO NOT TRY TO DEFEAT THEIR PURPOSE.

-  DO NOT attempt to clean or service rammer while it is running.
-  DO NOT operate equipment with safety devices or guards removed.
-  DO NOT operate equipment without air cleaner.
-  DO NOT remove air cleaner or air cleaner cover while operating rammer.
-  DO NOT alter engine governor mechanism. Engine must not be run at speeds other than those specified in Technical Data Section.
-  ALWAYS operate rammer with all safety devices and guards in place and in working order.

SAFETY DOES NOT STOP WHEN RAMMER OPERATION IS COMPLETED. IMPROPERLY STORED RAMMER CAN BE DAMAGED OR BE A SOURCE OF INJURY.

-  DO NOT leave a running machine unattended.
-  ALWAYS be sure rammer will not tip over, roll, slide, or fall when not being operated.
-  ALWAYS turn engine OFF when rammer is not being operated.
-  ALWAYS close fuel valve when rammer is not being operated.
-  ALWAYS remove or disconnect engine spark plug before servicing rammer, to avoid accidental start-up.

IN ORDER FOR RAMMER TO OPERATE PROPERLY FOR A LONG TIME, PERIODIC MAINTENANCE AND OCCASIONAL REPAIRS ARE NECESSARY. IF MAINTENANCE IS NOT CARRIED OUT OR REPAIRS ARE NOT MADE, RAMMER MAY ACT ERRATICALLY AND CAUSE MORE DAMAGE AND PERHAPS BECOME A SAFETY HAZARD.

-  ALWAYS replace safety devices and guards after repairs and maintenance.
-  ALWAYS keep area around muffler free of debris in order to reduce the chance of an accidental fire.
-  ALWAYS do Periodic Maintenance as recommended in Instruction Book.
-  ALWAYS clean debris from engine cooling fins.
-  ALWAYS replace worn or damaged components with spare parts designed and recommended by contractor for servicing this rammer.

COMMON SENSE, CAUTION, PROPER TRAINING AND FAMILIARITY WITH THE RAMMER BEING OPERATED IS THE BEST MEANS OF AVOIDING DAMAGE TO THE RAMMER AND INJURY TO THE OPERATOR.

WACKER machinery is designed using the latest technology with USER SAFETY in mind. When used by trained operators in the application for which it is intended, this machine will provide many years of safe, efficient, and dependable service.

I

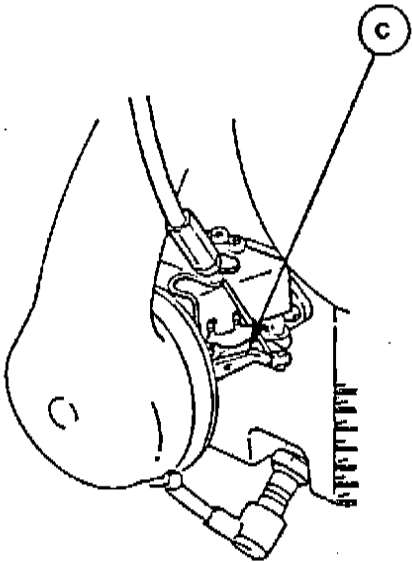

Serial No. 5799

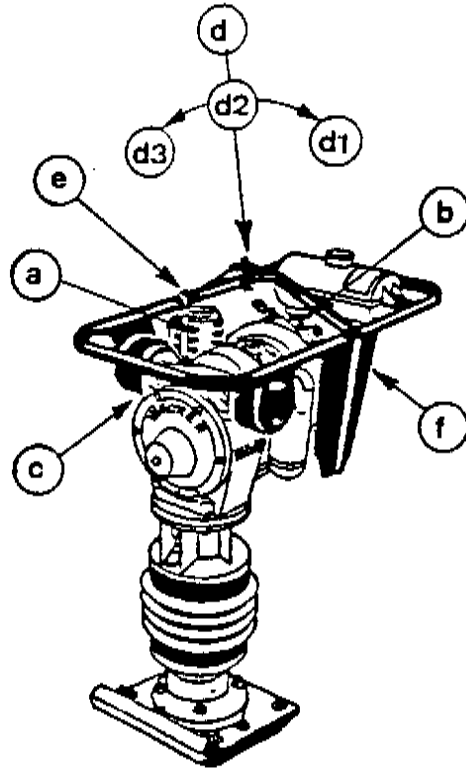

Ia

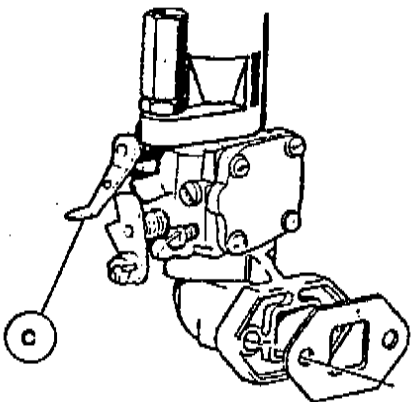

Serial No. 6295

II

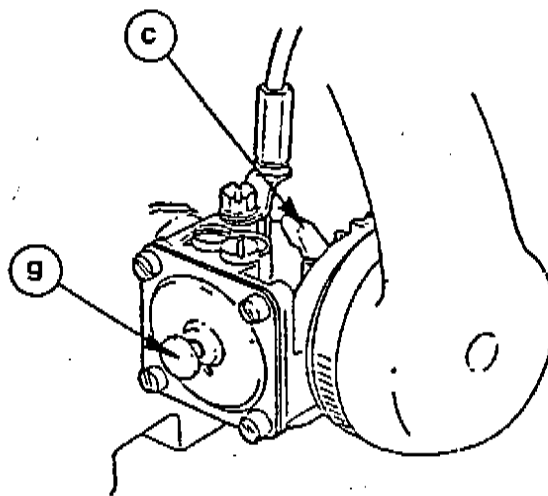

Serial Nos.: 5012, 5013 & 5028

OPERATIONRECOMMENDED FUEL

This rammer engine requires two-cycle gasoline/oil mixture.

Ratio 50:1

Gasoline	Oil	Gasoline	Oil
1 gallon	2.5 ounces	5 liters	100 ml
3 gallons	8.0 ounces	10 liters	200 ml
5 gallons	13.0 ounces	15 liters	300 ml

Mix regular gasoline and two-cycle/outboard motor oil in separate container before filling tank.

NOTE: Use 25:1 mixture for first tank of fuel.

BEFORE STARTING

1. Check air filter (a).  
NOTE: Air filters on models with S/N's starting with 6295 are relatively maintenance-free and do not have to be checked before starting.
2. Fill tank with proper fuel mixture.
3. Read "SAFETY FIRST".

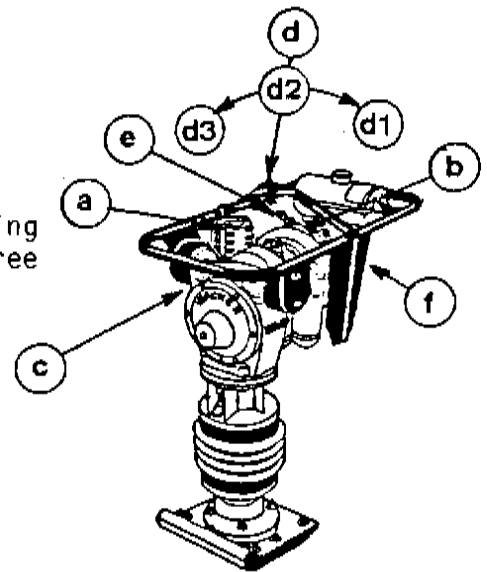
TO START

1. Open fuel valve (b).
2. Close choke on carburetor (c).
3. Open throttle no more than 1/4 (d2).
4. Press button on carburetor twice (g).  
NOTE: For machines with carburetor shown in Figure II.
5. Pull starter rope (e).
6. Open choke on carburetor.
7. Open throttle completely (d3) when engine starts.

NOTE: Cold engine should run approximately one (1) minute at idle (d1) to warm up.

TO STOP

1. Place throttle in "IDLE" (d1).
2. Press "STOP" button (f) until engine stops.
3. Close fuel valve (b).

PROPER OPERATION

1. Guide rammer with handle. DO NOT fight or overpower machine.
2. Shoe must hit parallel to ground. This will save on excessive shoe wear.

WACKER BS 60Y

PERIODIC MAINTENANCE SCHEDULE

TIME PERIOD	PROCEDURE	PAGE
Daily - before use	1. Check fuel level. 2. Check ramming system lubrication.	5 8,9
After first 10 hours	Tighten shoe hardware	-
Every 4 hours	* Check air filter.	8
Every 25 hours	1. Check spark plug. 2. Check shoe hardware. Tighten if necessary.	9 60-61
Every 50 hours	1. Clean engine exhaust ports. 2. Clean silencer.	- 8
Every 75 hours	Replace spark plug.	9
Every 100 hours	* Replace air filter element.	8,53
Every 200 hours	Clean starter.	-
Every 300 hours	Change ramming system oil.	8,9
Periodically	1. Tighten external hardware. 2. Clean engine cooling fins.	- -

\* Air filters on models with S/N's starting with 6295 are relatively maintenance-free and do not require periodic service.

MAINTENANCE AND INSPECTION

CARBURETOR ADJUSTMENTS

For machines with serial numbers beginning with 4144, 4160, 5013, and 6218 only:

Bing Carburetor

The Bing carburetor uses fixed fuel jets for both high and low speed operation.

Idle Speed

Adjust engine idle speed with throttle control closed. Attach tachometer and set idle speed screw a on carburetor to achieve specified idle speed. Refer to "Technical Data".

No other carburetor adjustments are required.

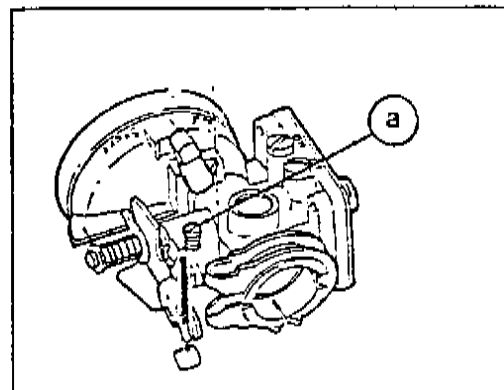

For machines with serial numbers beginning with 5799, 5838, 6238, 6240, and 6256 only:

### Tillotson Carburetor, Dual Needle Type (Tillotson Model HS226A)

Both high and low speed adjustment is required. Refer to "Technical Data" for correct idle and operating rpm. For best accuracy, use a tachometer when making carburetor adjustments.

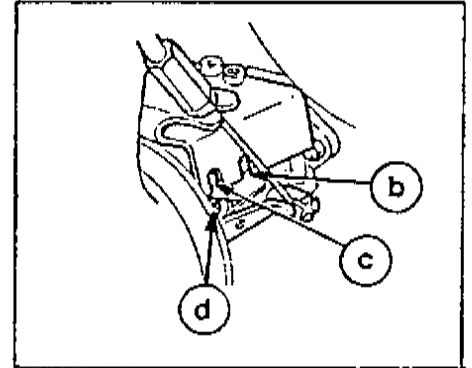

1. Turn in adjusting screws FINGERTIGHT.

**⚠ CAUTION:** DO NOT turn in so tight that valve seats are damaged.

2. Preset (open) adjustable fuel jets.

Low speed adjustment:  $\frac{3}{4}$  turn **(b)**

High speed adjustment: 1- $\frac{1}{4}$  turn **(c)**

3. After making initial setting, start engine and allow it to warm up to operating temperature, by running at high speed for 3-6 minutes.
4. Check adjustments by running machine at full throttle and at idle several times, with choke fully open. If further adjustments are necessary, follow procedure described below.

When making carburetor adjustments, turn adjusting screws in small increments, no more than  $\frac{1}{16}$  of a turn at a time.

Clockwise - LEAN

Counterclockwise - RICH

- a. Check low speed adjustment first. Accelerate machine to high speed. If engine bogs down or doesn't accelerate quickly, low speed adjustment is set incorrectly. If low speed adjustment is set too lean, engine will bog down and die during acceleration. If low speed adjustment is set too rich, engine will bog down and then accelerate slowly. Set low speed adjustment until good acceleration is achieved.

- b. Next, run machine at high speed (throttle fully open) and adjust high speed mixture for the best operating speed. Running engine too lean or too rich will cause low engine rpm. If high speed adjustment is too rich, engine will emit black smoke at exhaust.

**⚠ CAUTION:** Because the engine is lubricated by the fuel mixture, setting the high speed mixture too lean could cause engine to overheat and damage engine components.

5. Set engine idle speed with engine throttle control closed and choke fully open. Adjust idle speed screw **(d)** to obtain correct idle speed.

### Tillotson Carburetor, Single Needle Type (Tillotson Models HS235 & HS240)

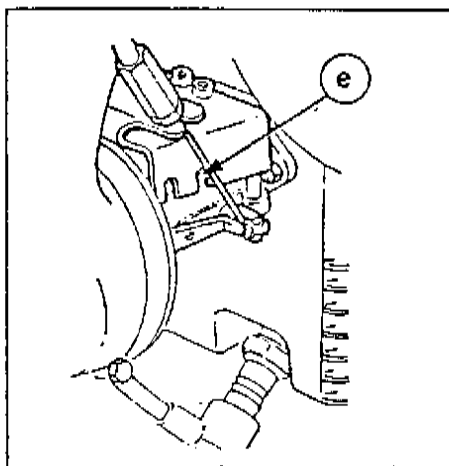

High speed fuel jet is fixed; NO high speed adjustment is required. Refer to "Technical Data" for correct idle and operating rpm. For best accuracy, use a tachometer when making carburetor adjustments.

1. Preset idle speed by turning adjusting screw **(e)** one turn out (counterclockwise).
2. Start engine and allow it to warm up to operating temperature, by running at high speed for 3-6 minutes.
3. Set engine idle speed with engine throttle control closed and choke fully open. Adjust idle mixture adjusting screw to obtain correct idle speed.



AIR CLEANER

1. To remove air filter unsnap spring clips from cover groove and remove cover.
2. Gently tap element on flat surface.  
NOTE: DO NOT use compressed air.
3. Position element on bracket. Replace cover. By pressing centers of clips toward cover the clips will snap into place. Be sure cover is properly seated and clips securely bedded in groove before resuming operation.

HEAVY DUTY AIR CLEANER

 CAUTION: Rammers with serial numbers beginning with 6295 are equipped with air cleaners which are relatively maintenance-free. DO NOT remove these air cleaners unless absolutely necessary.

A. COMPRESSION LOSS

1. Remove filter and inspect inside of mount.
2. If dust tracks are found, either the filter or the grommet must be replaced before resuming operation.

 CAUTION: If grommet is damaged, the filter must be cleaned before new grommet is installed. See cleaning instructions that follow.

B. POWER LOSS

1. Be sure that other causes for engine power loss are not present. See "Troubleshooting".
2. If power loss is determined to be due to air filter restriction, then dust and dirt must be removed using the following procedure:
  - a. Remove filter from mount.
  - b. Use compressed air directed from the inside of filter (clean side) to blow dust and debris from the filter.

 CAUTION: Air pressure at nozzle must not exceed 100 psi or filter damage will result.

C. CLEANING INSTRUCTIONS

Soot or oil-laden air can shorten the life of the air filter. Washing the filter, as outlined below, will remove some of these deposits:

1. Remove filter from mount.
2. Use compressed air to remove as much debris as possible. See Step b. above.
3. Rinse with fresh water through grommet hole until water runs clear.

 CAUTION: DO NOT use solvents, fuel oil, or gasoline to wash filter.

4. Plug grommet hole. Soak filter in a solution of warm water and low suds detergent for 15 minutes.

 CAUTION: Grommet hole must be plugged with a cork or tape to prevent dirty water from entering inside of filter.

NOTE: Longer periods of time (up to several hours) of soaking may be required, depending on amount of contamination.

5. Remove from solution and repeat rinse described in step 3. Allow the filter to air dry in a dust-free area.

 CAUTION: DO NOT use heat to speed drying; filter damage will result.

6. Inspect grommet before assembly and replace if worn or damaged. Insert grommet carefully to avoid damage. Install air filter on mount and secure with rubber-backed washers and locknuts.

NOTE: Silicone grease or liquid soap should be applied to grommet bore before installing on mount.

## WACKER BS 60Y

### LUBRICATION

1. Change rammer system oil after first 50 hours of operation. Thereafter, as recommended in periodic maintenance schedule.
2. With rammer on level surface, proper ramming system lubrication is indicated when 1/4 to 1/2 of the sight glass is covered by oil.

### SILENCER

Clean silencer by submerging it in solvent overnight. Shake solvent around inside and drain thoroughly before attaching to engine.

### TROUBLESHOOTING

PROBLEM/SYMPTOM	REASON/REMEDY	PAGE
Engine does not start, or stalls	<ol style="list-style-type: none"> <li>1. No fuel in tank.</li> <li>2. Spark plug fouled.</li> <li>3. Fuel valve closed.</li> </ol>	<p>5 9 5</p>
Engine does not accelerate, is hard to start or runs erratically	<ol style="list-style-type: none"> <li>1. Improper fuel mix. Too much oil.</li> <li>2. Spark plug fouled.</li> <li>3. Clean silencer and exhaust ports.</li> <li>4. Crankshaft seals are leaking.</li> <li>5. Air cleaner may be clogged.</li> </ol>	<p>5 9 8 42-43 8</p>
Engine overheats	<ol style="list-style-type: none"> <li>1. Improper fuel mix. Not enough oil.</li> <li>2. Carburetor set too lean.</li> <li>3. Clean cooling fins and fan blades.</li> </ol>	<p>5 7 -</p>
Engine runs; rammer does not tamp	<ol style="list-style-type: none"> <li>1. Inspect clutch for damage. Replace if necessary.</li> <li>2. Broken connecting rod or crankgear.</li> <li>3. Broken pinion or clutch drum shaft.</li> </ol>	<p>40-43 56-57 56-57</p>
Engine runs, rammer erratic	<ol style="list-style-type: none"> <li>1. Oil/grease on clutch.</li> <li>2. Broken/worn springs.</li> <li>3. Soil buildup on ramming shoe.</li> <li>4. Broken parts in ramming system or crankcase.</li> <li>5. Engine operating speed is too high.</li> </ol>	<p>40-43 60-61 60-61 56-61 9</p>

WACKER BS60Y

TECHNICAL DATA

<p>ENGINE SPEED</p>	<p>Full: 4800 ± 200 rpm          Idle: 1500 ± 100 rpm          Clutch Engagement: 2800 rpm</p>
<p>CYLINDER HEAD          COMPRESSION          (COLD)</p>	<p>120 - 140 psi (8 - 9.7 kg / cm<sup>2</sup>)</p>
<p>SPARK PLUG</p>	<p>Type: Champion UJ11G (WACKER 2005945)          Gap: .040 - .045 inches (1.0 - 1.1 mm)</p>
	<p>Type: Champion RL86C (WACKER 48333)          Gap: .025 inches (0.6 - 0.7 mm)</p>
<p>ENGINE          LUBRICATION</p>	<p>Type: Two-cycle or outboard motor oil conforming          to BIA-TC-W specifications           Ratio: 50:1   <u>NOTE:</u> Use 25:1 mixture for first tank of fuel.</p>
<p>PRIMING          SYSTEM          LUBRICATION</p>	<p>Type: Shell Rotella SAE 40 Oil           Quantity: 16 oz. (475 ml)</p>