

N 6 F S

## OPERATION and MAINTENANCE MANUAL

- MODEL:FS-50 FLOORING STAPLER
- MODEL:LFN-50 FLOORING NAILER

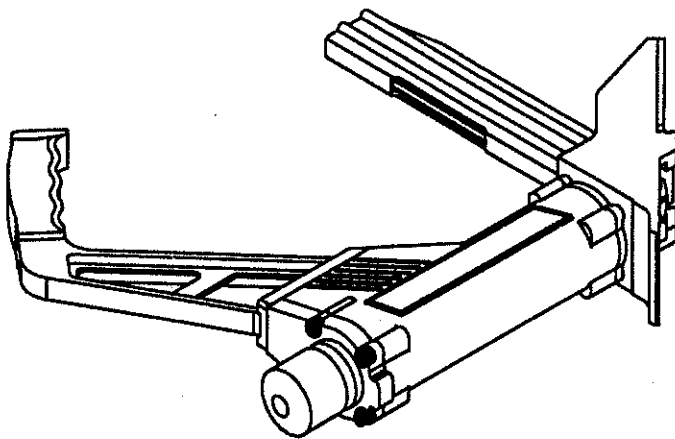

---

**▲ WARNING:**

BEFORE OPERATING THIS TOOL, ALL OPERATORS SHOULD STUDY MANUAL TO UNDERSTAND AND FOLLOW THE SAFETY WARNINGS AND INSTRUCTIONS. KEEP THESE INSTRUCTIONS WITH THE TOOL FOR FUTURE REFERENCE. IF YOU HAVE QUESTIONS, CONTACT YOUR DISTRIBUTOR.

## INTRODUCTION

The Flooring Tools is a precision-built tool, designed for high speed, high volume fastening. These tools will deliver efficient, dependable service when used correctly, and with care. As with any fine power tool, for best performance the manufacturer's instructions must be followed. Please study this manual before operating the tool and understand the safety warnings and cautions. The instructions on installation, operation and maintenance should be read carefully, and the manual kept for reference. NOTE: Additional safety measures may be required because of your particular application of the tool. Contact your representative or distributor with any questions concerning the tool and its use.

## INDEX

Tool Specifications	2
Air Supply: Fittings, Hoses, Filters, Air Consumption, Regulators, Operating Pressure	2
Safety Instructions	3
Lubrication	5
Loading the Tool	6
Tool Operation	7
Maintaining the Pneumatic Tool	8
Trouble Shooting	8
Maintaining the Tools	9
Nails/Staples Length Determination Chart	10

## TOOL SPECIFICATIONS

MODEL	LENGTH	HEIGHT	WIDTH	WEIGHT
F-S-50	18" (465mm)	18.8" (478mm)	3-1/8" (80mm)	4.1kg
LFN-50	18" (465mm)	18.8" (478mm)	3-1/8" (80mm)	4.0kg

## FASTENER SPECIFICATIONS:

MODEL	CROWN WIDTH	WIRE SIZE	MAX LENGTH
F-S-50	1/2" (13mm)	15-15 1/2 GA.	2" (50mm)
LFN-50			2" (50mm)

## TOOL AIR FITTING:

This tool uses a 3/8" N.P.T. male plug. The inside diameter should be .275" (7mm) or larger. The fitting must be capable of discharging tool air pressure when disconnected from the air supply.

## OPERATING PRESSURE:

70 to 90 p.s.i.g. (4.9 to 6.3 kg/cm<sup>2</sup>). Select the operating pressure within this range for best fastener performance.

**DO NOT EXCEED THIS RECOMMENDED OPERATING PRESSURE.**

## AIR CONSUMPTION:

The Tool requires 4.2 cubic feet per minute (221 liters per minute) of free air to operate at the rate of 60 fasteners per minute, at 80 p.s.i. (5.6 kg/cm<sup>2</sup>). Take the actual rate at which the tool will be run to determine the amount of air required. For instance, if your fastener usage averages 30 fasteners per minute, you need 50% of the tool's c.f.m. of free air which is required to operate the tool at 60 fasteners per minute.

## NOISE CHARACTERISTIC VALUES IN ACCORDANCE WITH ENXXXI :

A-weighted single-event sound pressure level at operator's position:  $L_{pA,1m} = 95dBA$   
 A-weighted single-event sound power level:  $L_{pA,1m} = 102dBA$   
 A-weighted single-event surface sound pressure level:  $L_{pA,1m} = 89dBA$

## VIBRATION CHARACTERISTIC VALUES IN ACCORDANCE WITH

### ISO 8662; PART II :

Weighted root mean square acceleration = 2.7 m/s<sup>2</sup>

## SAFETY INSTRUCTIONS

### ⚠ WARNING:

EYE PROTECTION which conforms to ANSI specifications and provides protection against flying particles both from the FRONT and SIDE should ALWAYS be worn by the operator and others in the work area when loading, operating or servicing this tool. Eye protection is required to guard against flying fasteners and debris, which could cause severe eye injury.



The employer and/or user must ensure that proper eye protection is worn. Eye protection equipment must conform to the requirements of the American National Standards Institute, ANSI Z87.1-1989 and provide both frontal and side protection. NOTE: Non-side shielded spectacles and face shields alone do not provide adequate protection.



CAUTION: ADDITIONAL SAFETY PROTECTION will be required in some environments. For example, the working area may include exposure to noise level which can lead to hearing damage. The employer and user must ensure that any necessary hearing protection is provided and used by the operator and others in the work area. Some environments will require the use of head protection equipment. When required, the employer and user must ensure that head protection conforming to ANSI Z89.1 1986 is used.

## AIR SUPPLY AND CONNECTIONS

### ⚠ WARNING:

Do not use oxygen, combustible gases, or bottled gases as a power source for this tool as tool may explode, possibly causing injury.

### ⚠ WARNING:

Do not use supply sources which can potentially exceed 200 P.S.I.G. as tool may burst, possibly causing injury.

### ⚠ WARNING:

The connector on the tool must not hold pressure when air supply is disconnected. If a wrong fitting is used, the tool can remain charged with air after disconnecting and thus will be able to drive a fastener even after the air line is disconnected possibly causing injury.

### ⚠ WARNING:

Do not pull trigger or depress contact arm while connected to the air supply as the tool may cycle, possibly causing injury.

### ⚠ WARNING:

Always disconnect air supply: 1.) Before making adjustments; 2.) When servicing the tool; 3.) When clearing a jam; 4.) When tool is not in use; 5.) When moving to a different work area, as accidental actuation may occur, possibly causing injury.

## LOADING TOOL

### ⚠ WARNING:

When loading tool: 1.) Never place a hand or any part of body in fastener discharge area of tool; 2.) Never point tool at anyone; 3.) Do not pull the trigger or depress the trip as accidental actuation may occur, possibly causing injury.

## OPERATION

### ⚠ WARNING:

Always handle the tool with care: 1.) Never engage in horseplay; 2.) Never pull the trigger unless nose is directed toward the work; 3.) Keep others a safe distance from the tool while tool is in operation as accidental actuation may occur, possibly causing injury.

### ⚠ WARNING:

The operator must not hold the trigger pulled on contact arm tools except during fastening operation as serious injury could result if the trip accidentally contacted someone or something, causing the tool to cycle.

### ⚠ WARNING:

Keep hands and body away from the discharge area of the tool. A contact arm tool may bounce from the recoil of driving a fastener and an unwanted second fastener may be driven possibly causing injury.

### ⚠ WARNING:

Check operation of the contact arm mechanism frequently. Do not use the tool if the arm is not working correctly as accidental driving of a fastener may result. Do not interfere with the proper operation of the contact arm mechanism.

### ⚠ WARNING:

Do not drive fasteners on top of other fasteners or with the tool at an overly steep angle as this may cause deflection of fasteners which could cause injury.

### ⚠ WARNING:

Do not drive fasteners close to the edge of the work piece as the wood may split, allowing the fastener to be deflected possibly causing injury.

## MAINTAINING THE TOOL

### ⚠ WARNING:

When working on air tools note the warnings in this manual and use extra care when evaluating problem tools.

**OPERATION**

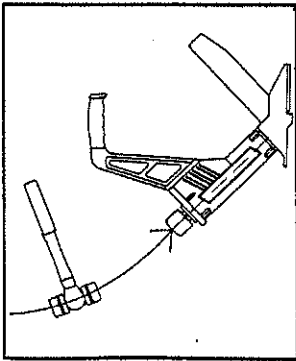

**SERVICE PARTS:  
PISTON ROD ASM.  
PART NO. C18000901A**

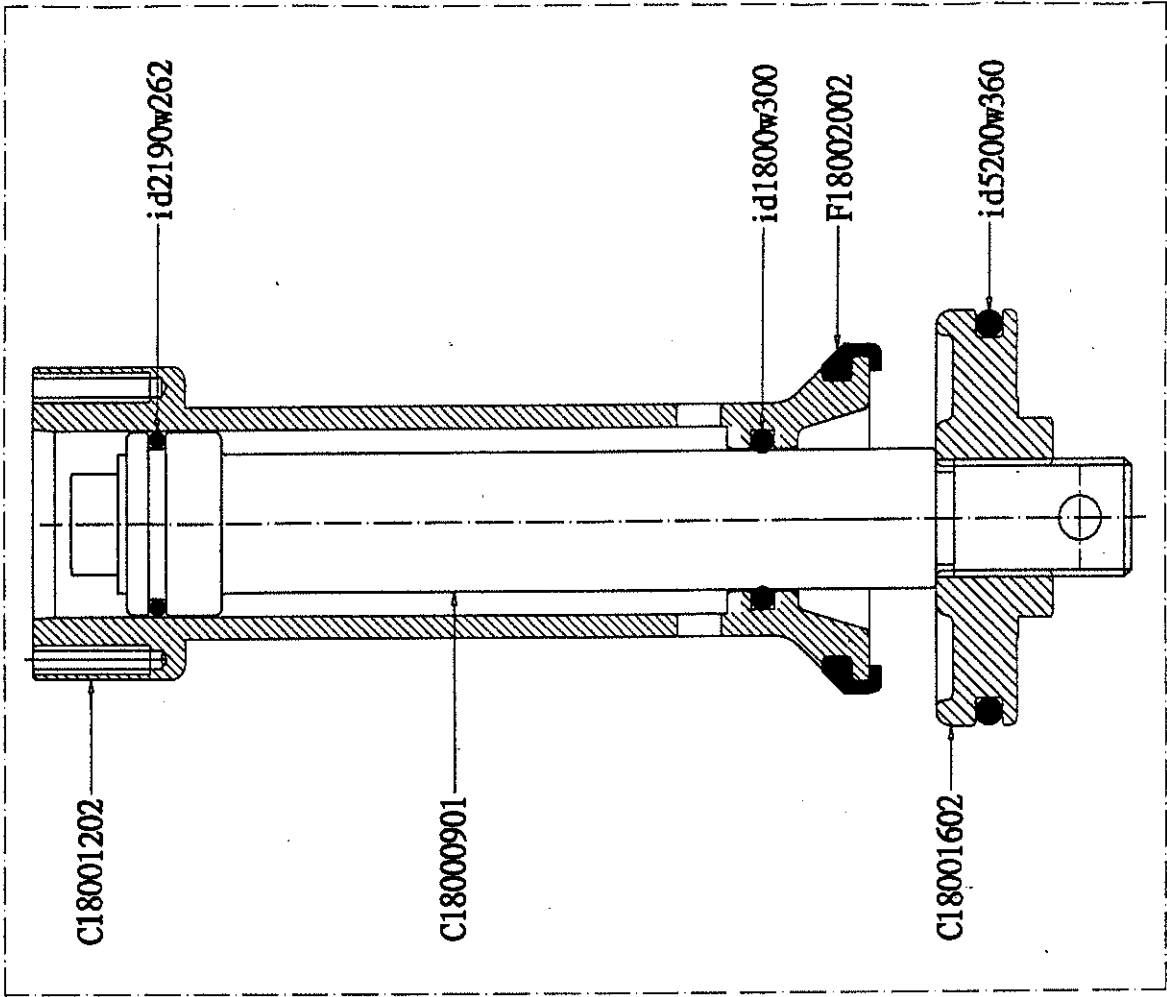

**Caution Regarding Use of this Tool to Install Pre-finished Flooring**  
This Flooring Tool was designed for use in installing unfinished hardwood flooring. It can be used to install pre-finished flooring however caution must be used to ensure that the finish is not damaged by the tool. It is recommended that the tool be tested on a sample section to be certain that the tool and technique of use do not leave marks on the finish. This procedure should be followed before each job due to variations in flooring and tool condition.

## Installation instructions for flooring tool

1. Remove hammer face with box wrench.
2. Remove four (4) head cap screws. Take off cap. Noting presence of O-ring which remains in cap.
3. Remove four (4) screws with connect plunger to poppet. pull plunger out of cylinder and remove O-ring.
4. Remove O-ring and clean mating surfaces on plunger and poppet.
5. Remove four (4) foot screws thus detaching the foot/magazine assembly and shoe from body.
6. Manually pull rubber bumper out of the body. Visually inspect rubber bumper for wear, deformation and/or cracking. If defective, replace with bumper.
7. Grasp driver with thumb and forefinger and pull out of cylinder body. The piston, poppet and piston rod will follow.
8. Unscrew lock nut from piston rod. Do not deform the soft aluminum part, use Box wrench. Slide piston off piston Rod.
9. Clean all parts with clean dry rag.
10. Install new o-rings with the accompanying drawing. Coat the o-rings, grooves, and cylinder walls evenly with grease and install.
11. Reassemble poppet and piston onto piston rod, blade into the slot and pin into hole, thread lock nut until it is exactly flush with end of piston rod. Reinsert piston rod followed by poppet, piston and driver in body.
12. Reinstall bumper and flush it into the bottom of body.
13. Guide foot/magazine assembly and shoe onto driver up against body. Thread and tighten the four (4) foot screws.
14. Returning to the top portion of the tool, reinstall new Gasket onto plunger. Insert plunger with new o-ring into cylinder using an ice pick shaped instrument to align the four (4) screw holes and onto the threads of the poppet.
15. Using loctite on the threads, insert four (4) new screws with spring washers and tighten.
16. Reinstall new cap.
17. Replace cap with four (4) head cap screws and tighten.
18. Replace hammer face.
19. Check tool operation as explained in Operator's Manual and inspect for leaks.

## AIR SUPPLY AND CONNECTIONS

### **WARNING:**

Do not use oxygen, combustible gases, or bottled gases as a power source for this tool as tool may explode, possibly causing injury.

### **FITTINGS:**

Install a male plug on the tool which is free flowing and which will release air pressure from the tool when disconnected from the supply source.

### **HOSES:**

Air hoses should have a minimum of 150 p.s.i. (10.6 kg/cm<sup>2</sup>) working pressure rating or 150 percent of the maximum pressure that could be produced in the air system. The supply hose should contain a fitting that will provide "quick disconnecting" from the male plug on the tool.

### **SUPPLY SOURCE:**

Use only clean regulated compressed air as a power source for this tool. **NEVER USE OXYGEN, COMBUSTIBLE GASES, OR BOTTLED GASES, AS A POWER SOURCE FOR THIS TOOL AS TOOL MAY EXPLODE.**

### **REGULATOR:**

A pressure regulator with an operating pressure of 0 - 125 p.s.i. (0 - 8.79 KG/CM<sup>2</sup>) is required to control the operating pressure for safe operation of this tool. Do not connect this tool to air pressure which can potentially exceed 200 p.s.i. (14 KG/CM<sup>2</sup>) as tool may fracture or burst, possibly causing injury.

### **OPERATING PRESSURE:**

Do not exceed recommended maximum operating pressure as tool wear will be greatly increased. The air supply must be capable of maintaining the operating pressure at the tool. Pressure drops in the air supply can reduce the tool's driving power. Refer to "TOOL SPECIFICATIONS" for setting the correct operating pressure for the tool.

### **FILTER:**

Dirt and water in the air supply are major causes of wear in pneumatic tools. A filter will help to get the best performance and minimum wear from the tool. The filter must have adequate flow capacity for the specific installation. The filter has to be kept clean to be effective in providing clean compressed air to the tool. Consult the manufacturer's instructions on proper maintenance of your filter. A dirty and clogged filter will cause a pressure drop which will reduce the tool's performance.

## LUBRICATION

Frequent, but not excessive, lubrication is required for best performance. Oil added through the air line connection will lubricate the internal parts. Use Air Tool Lubricant, Mobil Velocite #10, or equivalent. Do not use detergent oil or additives as these lubricants will cause accelerated wear to the seals and bumpers in the tool, resulting in poor tool performance and frequent tool maintenance.

If no airline lubricator is used, add oil during use into the air fitting on the tool once or twice a day. Only a few drops of oil at a time is necessary. Too much oil will only collect inside the tool and will be noticeable in the exhaust cycle.

### **COLD WEATHER OPERATION:**

For cold weather operation, near and below freezing, the moisture in the air line may freeze and prevent tool operation. We recommend the use of WINTER FOR-

MULA air tool lubricant or permanent antifreeze (ethylene glycol) as a cold weather lubricant.

**CAUTION:** Do not store tools in a cold weather environment to prevent frost or ice formation on the tools operating valves and mechanisms that could cause tool failure.

**NOTE:** Some commercial air line drying liquids are harmful to "O"-rings and seals - do not use these low temperature air dryers without checking compatibility.

## LOADING THE TOOL

### WARNING:



EYE PROTECTION which conforms to ANSI specifications and provides protection against flying particles both from the FRONT and SIDE should ALWAYS be worn by the operator and others in the work area when loading, operating or servicing this tool. Eye protection is required to guard against flying fasteners and debris, which could cause severe eye injury.

The employer and/or user must ensure that proper eye protection is worn. Eye protection equipment must conform to the requirements of the American National Standards Institute, ANSI Z87.1-1989 and provide both frontal and side protection. NOTE: Non-side shielded spectacles and face shields alone do not provide adequate protection.

### WARNING:

#### TO PREVENT ACCIDENTAL INJURIES:

- Never place a hand or any other part of the body in nail discharge area of tool while the air supply is connected.
- Never point the tool at anyone else.
- Never engage in horseplay.
- Never pull the trigger unless nose is directed at the work.
- Always handle the tool with care.
- Do not pull the trigger or depress the trip mechanism while loading the tool.

## FS-50

### STAPLE LOADING:

Pull pusher back. Insert stick of staples. Push pusher forward. The tool is now ready to operate.

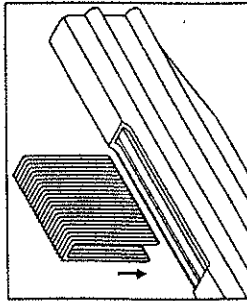

## LFN-50

### NAIL LOADING:

Insert nails. Pull pusher assembly back to engage pusher to strip of nails. Tool is now ready to operate.

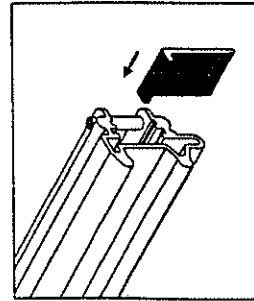

## PARTS INCLUDED IN THIS KIT:

1. BUMPER (F18002302)(FOR 1/2" FLOORING)
2. ADAPTOR PAD (F18002502)(FOR 1/2" FLOORING)
3. OIL BOTTLE (JLUB01)
4. BOX WRENCH (D18006001)
5. HEX WRENCH (JHW0407025)
6. HEX WRENCH (JHW0508028)
7. HEX WRENCH (JHW0609032)
8. 5 PCS O-RINGS
9. GASKET (F18001101)

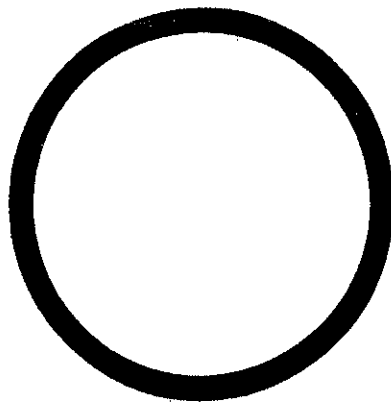

id4770w350

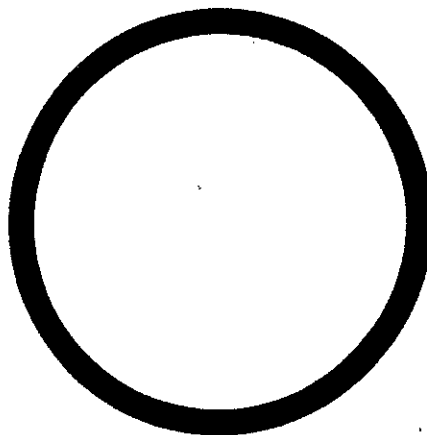

id5200w360

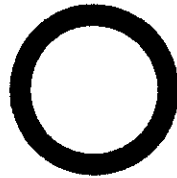

id1800W300

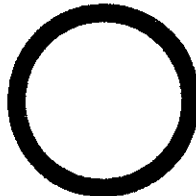

id2190w262

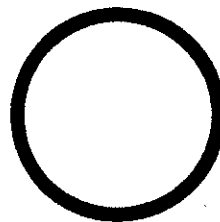

id2600w200

## NAILS/STAPLES LENGTH DETERMINATION CHART

This chart will assist you in determining the proper length of NAIL/STAPLE to use for various thicknesses of flooring when the sub-flooring member varies as to species and thickness. Vertical penetration of the NAIL/STAPLE under the hardwood floor is shown for each application.

25/32" FLOORING

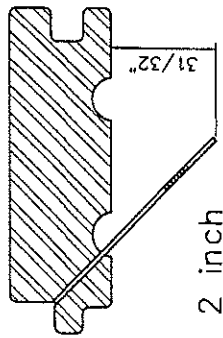

33/32" FLOORING

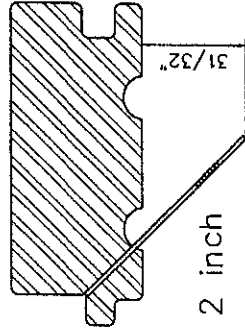

25/32" FLOORING

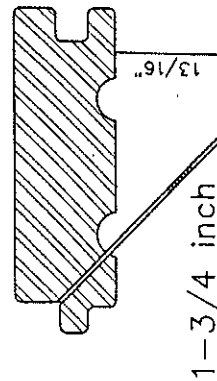

1/2" FLOORING

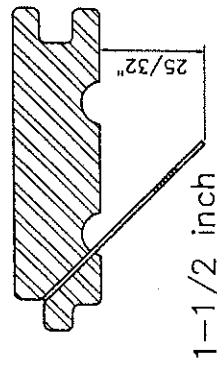

## TOOL OPERATION

### **WARNING:**



EYE PROTECTION which conforms to ANSI specifications and provides protection against flying particles both from the FRONT and SIDE should ALWAYS be worn by the operator and others in the work area when loading, operating or servicing this tool. Eye protection is required to guard against flying fasteners and debris, which could cause severe eye injury.

The employer and/or user must ensure that proper eye protection is worn. Eye protection equipment must conform to the requirements of the American National Standards Institute, ANSI Z87.1-1989 and provide both frontal and side protection. NOTE: Non-side shielded spectacles and face shields alone do not provide adequate protection.

### BEFORE HANDLING OR OPERATING THIS TOOL:

- I. READ AND UNDERSTAND THE WARNINGS CONTAINED IN THIS MANUAL
- II. REFER TO "TOOL SPECIFICATIONS" IN THIS MANUAL TO IDENTIFY THE OPERATING SYSTEM ON YOUR TOOL.

### IN ADDITION TO THE OTHER WARNINGS CONTAINED IN THIS MANUAL OBSERVE THE FOLLOWING FOR SAFE OPERATION

- Use the pneumatic tool only for the purpose for which it was designed.
- Never use this tool in a manner that could cause a fastener to be directed toward the user or others in the work area.
- Do not use the tool as a hammer.
- Always carry the tool by the handle. Never carry the tool by the air hose.
- Always be aware that misuse and improper handling of this tool can cause injury to yourself and others.
- Never leave a tool unattended with the air hose attached.
- Do not operate this tool if it does not contain a legible WARNING LABEL.
- Do not continue to use a tool that leaks air or does not function properly. Notify your nearest store representative if your tool continues to experience functional problems.

## MAINTAINING THE PNEUMATIC TOOL

**WARNING:** When working on air tools, note the warnings in this manual and use extra care evaluating problem tools.

**CAUTION:** Pusher spring (constant force spring). Caution must be used when working with the spring assembly. The spring is wrapped around, but not attached to, a roller. If the spring is extended beyond its length, the end will come off the roller and the spring will roll up with a snap, with a chance of pinching your hand. Also the edges of the spring are very thin and could cut. Care must also be taken to insure no permanent kinks are put in the spring as this will reduce the springs force.

### ASSEMBLY PROCEDURE FOR SEALS:

When repairing a tool, make sure the internal parts are clean and lubricated. Use LITHIUM grease or equivalent on all "O"-rings. Coat each "O"-ring with "O"-LUBE before assembling. Use a small amount of oil on all moving surfaces and pivots. After reassembly add a few drops of Air Tool Lubricant through the air line fitting before testing.

### AIR SUPPLY-PRESSURE AND VOLUME:

Air volume is as important as air pressure. The air volume supplied to the tool may be inadequate because of undersize fittings and hoses, or from the effects of dirt and water in the system. Restricted air flow will prevent the tool from receiving an adequate volume of air, even though the pressure reading is high. The results will be slow operation, misfeeds or reduced driving power. Before evaluating tool problems for these symptoms, trace the air supply from the tool to the supply source for restrictive connectors, swivel fittings, low points containing water and anything else that would prevent full volume flow of air to the tool.

## TROUBLE SHOOTING

PROBLEM	CAUSE	CORRECTION
Trigger valve housing leaks air	O-ring cut or cracked	Replace O-ring
Trigger valve stem leaks air	O-rings/seals cut or cracked	Replace trigger valve assembly
Frame/nose leaks air	Loose nose screws	Tighten and recheck
	O-ring is cut or cracked	Replace O-ring
Frame/cap leaks air	Bumper cracked/worn	Replace bumper
	Damaged seal	Replace seal
	Cracked/worn head valve bumper	Replace bumper
Failure to cycle	Loose cap screws	Tighten and recheck
	Air supply restriction	Check air supply equipment
	Tool dry, lack of lubrication	Use Air Tool Lubricant
	Worn head valve O-rings	Replace O-rings
Lack of power; slow to cycle	Head valve stuck in cap	Disassemble/Check/Lubricate
	Tool dry, lacks lubrication	Use Air Tool Lubricant
	Broken cylinder cap spring	Replace cap spring
	O-rings/seals cut or cracked	Replace O-rings/seals
	Exhaust blocked	Check bumper, head valve spring, muffler
	Dirt/bar build up on driver	Disassemble nose/driver to clean
	Head valve dry	Disassemble/Lubricate
	Air pressure too low	Check air supply equipment
	Worn bumper	Replace bumper
	Terrific in driver channel	Disassemble and clean nose and driver
Skipping fasteners; intermittent feed	Air restriction/inadequate air flow through quick disconnect socket and plug	Replace quick disconnect fittings
	Worn piston O-ring	Replace O-ring, check driver
	Tool dry, lacks lubrication	Use Air Tool Lubricant
	Damaged pusher spring	Replace spring
	Low air pressure	Check air supply system to tool
	Loose magazine nose screws	Tighten all screws
	Fasteners too short for tool	Use only recommended fasteners
	Bent fasteners	Discontinue using these fasteners
	Wrong size fasteners	Use only recommended fasteners
	Broken/chipped driver	Replace driver (check piston O-ring)
	Dry/dirty magazine	Clean/lubricate use Air Tool Lubricant
Fasteners jam in tool	Worn magazine	Replace magazine
	Driver channel worn	Replace nose/check door
	Wrong size fasteners	Use only recommended fasteners
	Bent fasteners	Discontinue using these fasteners
	Loose magazine/nose screws	Tighten all screws
	Broken/chipped driver	Replace driver

## MAINTAINING THE SERIES TOOLS

### TO REPLACE DRIVING BLADE:

1. Holding the piston rod with box wrench, and remove the lock nut (17')
2. Push out the pin (10') and remove the blade.
3. Install a new blade in the slot and replace the pin.
4. Screw on the retaining lock nut (17'), using the same tools, if the lock nut becomes

Worn and loose after frequent removals. It should be replaced.

5. Check the fit, there should be some sideways movement between the blade and lock nut Assembly, this is desirable and helps the blade to align itself with mating parts.

6. Reassemble the components, be sure to align the driving blade with the slot in the Adapter Foot assembly.

### DRIVING BLADE ASSEMBLY-REMOVAL:

1. Disconnect the air supply.
2. Remove hammer face (1') with box wrench.
3. Unscrew & remove Body cap (4').
4. Unscrew the four cap screws holding the plunger (6') to the poppet (12').
5. Pull the plunger up and out of the Body (19') cavity.
6. Turn the tool over and remove the four cap screws (26'), that fasten the Adapter Foot and magazine Assembly to the tool Body and the Assembly off the Body.
7. Remove the Rubber Bumper (23')

8. Pull the Driving Blade Assembly out of the Nailers Body.

9. Hold the Piston Rod (9') with box wrench over its hex end and opposite the lock nut (17')

Do not use pliers anywhere on the metal parts, they can damage the sealing surfaces.

10. Remove the Lock Nut (17'), pin (10') and Driving Blade (14').

11. Unscrew the Piston from the Piston Rod separate the Piston, Piston Rod and Poppet (12').

### TO REPLACE DRIVER GUIDE PLATE AND NOSE:

1. Separate the magazine from the foot (30') by removing four socket head screws (28').
2. Remove and replace driver guide plate (31') or nose (33').