



<b>1</b>	<b>Preface</b> .....	<b>5</b>
<b>2</b>	<b>Introduction</b> .....	<b>6</b>
2.1	Using the manual .....	6
2.2	Storage location of the manual .....	6
2.3	Accident prevention regulations.....	6
2.4	More information.....	6
2.5	Target group .....	6
2.6	Explanation of symbols.....	6
2.7	Wacker Neuson Contact partner .....	7
2.8	Disclaimer .....	7
2.9	Product identification of the machine.....	7
<b>3</b>	<b>Security</b> .....	<b>8</b>
3.1	Policy .....	8
3.2	Areas of responsibility of the operator .....	8
3.3	Operator responsibilities .....	9
3.4	Personnel qualification.....	9
3.5	General sources of danger .....	9
3.6	General safety instructions .....	9
3.7	Specific safety instructions – Vibratory plates .....	10
3.8	General safety instructions - Combustion engines .....	10
3.9	General safety instructions – fuel, lubricants and coolants.....	11
3.10	Maintenance .....	11
3.11	Personal Protective Equipment .....	11
3.12	Safety devices .....	12
3.13	Behavior in dangerous situations.....	13
<b>4</b>	<b>Safety and information labels</b> .....	<b>14</b>
<b>5</b>	<b>Setup and function</b> .....	<b>16</b>
5.1	Standard package .....	16
5.2	Application areas .....	16
5.3	Short description.....	16
5.4	Versions.....	16
<b>6</b>	<b>Components and operator’s controls</b> .....	<b>17</b>
6.1	Components .....	17
6.2	Operator’s controls .....	17
<b>7</b>	<b>Transport</b> .....	<b>18</b>
7.1	Loading and transport.....	18
<b>8</b>	<b>Operation and use</b> .....	<b>20</b>
8.1	Initial operation .....	20
8.2	Before commissioning .....	20
8.3	Notes about operation .....	20
8.4	Commissioning .....	21
8.5	Operation .....	22
8.6	Decommissioning .....	22
<b>9</b>	<b>Maintenance</b> .....	<b>23</b>
9.1	Maintenance table .....	24
9.2	Maintenance jobs.....	24
<b>10</b>	<b>Troubleshooting</b> .....	<b>31</b>
10.1	Fault table.....	31



<b>11</b>	<b>Accessories</b> .....	<b>32</b>
<b>12</b>	<b>Technical data</b> .....	<b>33</b>
	12.1 WP1540 .....	33
	12.2 WP1550 .....	34
	12.3 Combustion engine .....	35
<b>13</b>	<b>Technical data</b> .....	<b>36</b>
	13.1 VP1135 .....	36
	13.2 VP1340 .....	37
	13.3 VP1550 .....	38
	13.4 VP2050 .....	39
	13.5 Combustion engine .....	40
<b>14</b>	<b>Emission control systems information and warranty</b> .....	<b>41</b>
	<b>EC declaration of conformity</b> .....	<b>43</b>
	<b>EC declaration of conformity</b> .....	<b>44</b>
	<b>EC declaration of conformity</b> .....	<b>45</b>
	<b>EC declaration of conformity</b> .....	<b>46</b>



## **1 Preface**

This operator's manual contains important information and procedures for the safe, proper and economic operation of this Wacker Neuson machine. Carefully reading, understanding and observing is an aid to avoiding hazards, repair costs and downtime, and therefore to increasing the availability and service life of the machine.

This operator's manual is not a manual for extensive maintenance or repair work. Such work should be carried out by Wacker Neuson service or by technically trained personnel. The Wacker Neuson machine should be operated and maintained in accordance with this operator's manual. An improper operation or improper maintenance can pose dangers. Therefore, the operator's manual should be constantly available at the location of the machine.

**Defective machine parts must be exchanged immediately!**

If you have any questions concerning the operation or maintenance, a Wacker Neuson contact person is always available.



## 2 Introduction

### 2.1 Using the manual

This manual is to be considered part of the machine and should be carefully stored during the entire service life of the machine. This manual shall be transferred to subsequent owners or users of the machine.

### 2.2 Storage location of the manual

This manual is part of the machine and must be kept in the immediate vicinity of the machine and made accessible to staff at all times.

If this manual is lost, or if a second copy is required, there are two options to obtain a replacement:

- Download from the Internet [www.wackerneuson.com](http://www.wackerneuson.com)
- Contact your Wacker Neuson contact partner.

### 2.3 Accident prevention regulations

In addition to the notes and safety instructions in this manual, the local accident prevention regulations as well as the national health and safety regulations apply.

### 2.4 More information

This manual applies to various machine types from one product series. For this reason, some figures may vary slightly in appearance from the machine purchased. Depending on the model, there may be descriptions of components that are not included in the standard package.

The information contained in this manual is based on machines manufactured up to the time of printing. Wacker Neuson reserves the right to change this information.

The manufacturer shall immediately include any modifications or additions in this manual.

### 2.5 Target group

Individuals working with this machine must be regularly trained on the dangers of handling the machine.

This operator's manual is intended for the following persons:

Operating personnel:

These individuals have been trained on the machine and informed about the possible dangers in the event of improper conduct.

Technically trained personnel:

These people have professional training as well as additional knowledge and experience. They are able to assess the tasks assigned to them and recognize possible dangers.

### 2.6 Explanation of symbols

This manual contains specially emphasized safety instructions in the following categories: **DANGER**, **WARNING**, **CAUTION** and **NOTICE**.

Before performing any work on or with this machine, the notes and safety instructions must be read and understood. All notes and safety instructions in this manual must be passed on to the maintenance, repair, and transport personnel.



#### **DANGER**

This combination of symbol and signal word indicates a hazardous situation that will lead to death or serious injury if it is not avoided.



#### **WARNING**

This combination of symbol and signal word indicates a hazardous situation that can lead to death or serious injury if it is not avoided.



#### **CAUTION**

This combination of symbol and signal word indicates a hazardous situation that can lead to minor injury or damage to the machine if it is not avoided.



---

**NOTICE**

Supplementary information.

---

**2.7 Wacker Neuson Contact partner**

Depending on the country, the Wacker Neuson contact partner is a Wacker Neuson service department, a Wacker Neuson affiliate, or a Wacker Neuson dealer.

On the Internet at [www.wackerneuson.com](http://www.wackerneuson.com).

The manufacturer's address can be found at the beginning of this manual.

**2.8 Disclaimer**

For the following violations, Wacker Neuson dismisses any liability for personal injury or material damage:

- Failure to follow this manual.
- Unintended use.
- Deployment of untrained personnel.
- Using non-approved spare parts and accessories.
- Improper handling.
- Structural modifications of any kind.
- Failure to observe the "General Terms and Conditions" (GT&Cs).

**2.9 Product identification of the machine**

**Data of the nameplate**

The nameplate contains information that uniquely identifies this machine. This information is required for ordering spare parts and when inquiring about technical issues.

- Enter information about the machine in the following table:

<b>Designation</b>	<b>Your information</b>
Group and model	
Year of manufacture	
Serial number	
Version no.	
Item number	



## 3 Security

---

### NOTICE

Read and comply with all notes and safety instructions in this manual. Failure to comply with these instructions can cause electric shock, fire and/or serious injuries as well as damage to the machine and/or damage to other objects. Keep safety instructions and notes for the future.

---

### 3.1 Policy

#### In keeping with the latest technological developments

The machine has been built in keeping with the latest technological developments and the recognized technical safety rules. Nevertheless, improper use can result in hazards to life and limb of the user or third parties as well as damage to the equipment and other material assets.

#### Proper use

The machine may only be used for the following purposes:

- Soil compaction.
- Asphalt compaction.
- Vibration of sett paving (paving stones).

The machine may not be used for the following purposes:

- Compaction of very cohesive soils.
- Compaction of frozen soils.
- Compaction of hard, non-compressible soils.
- Compaction of non-load-bearing soils.

Use in accordance with the intended purpose also includes the observation of all safety instructions in this manual as well as complying with the prescribed care and maintenance instructions.

Any use that exceeds or is not in accordance with the intended purpose is considered improper. The manufacturer's liability and warranty are canceled for any damage resulting from improper use. The risk lies entirely with the operator.

#### Structural changes

Structural modifications may not be undertaken without the written permission of the manufacturer. Unapproved structural changes may result in risks to the operator and/or third parties as well as damage to the machine.

In the case of unauthorized structural changes, the liability and warranty of the manufacturer are no longer applicable.

#### The following cases are considered structural changes:

- Opening the machine and the permanent removal of components.
- Installing spare parts that do not originate from Wacker Neuson or are not comparable in the design system and quality of the original parts.
- Attaching any accessories that do not originate from Wacker Neuson.

Spare parts or accessories that originate from Wacker Neuson can be safely mounted. They can be found on the Internet under [www.wackerneuson.com](http://www.wackerneuson.com).

### 3.2 Areas of responsibility of the operator

The operator is the individual who personally operates this machine for industrial or commercial purposes or who entrusts a third party with the use. The operator bears legal responsibility for his/her protection as well as that of third parties.

The user must make the operator's manual available to the operator and ensure that this has been read and understood.

The manual must be kept next to the machine or place of use.

The operator must hand over the manual to subsequent operators or owners of the machine.



The country-specific regulations, standards, and guidelines on accident prevention and environmental protection must be observed. The operator's manual must be supplemented with additional instructions that take regulatory, national or generally applicable safety standards into consideration.

### **3.3 Operator responsibilities**

- Know and implement the applicable industrial safety regulations.
- Use a risk assessment to identify the dangers that result from the working conditions at the site of application.
- Create operating instructions for the operation of this machine.
- Periodically check whether the user instructions correspond to the current state of regulations.
- Clearly regulate and specify responsibilities for operation, troubleshooting, maintenance, and cleaning.
- Regularly train employees and inform them about potential hazards.
- Provide employees with the necessary equipment.

### **3.4 Personnel qualification**

This machine may only be installed and operated by trained personnel.

Faulty operation, misuse or operation by untrained personnel can endanger health of the operator or third parties and lead to damage to or total loss of the machine.

**In addition, the operator should be:**

- Physically and mentally fit
- Not under the influence of drugs, alcohol or medication that can impair responsiveness.
- Familiar with the safety instructions in this manual.
- Familiar with the intended use of this machine.
- Have reached the minimum age of 18 to operate this machine.
- Be instructed in the independent operation of the machine.
- Be authorized to operate machines and systems independently according to the standards of safety engineering.

### **3.5 General sources of danger**

Residual dangers in particular are hazards when dealing with machines that, despite a safe design, cannot be eliminated.

These residual dangers are not obvious and may be the source of a possible injury or health hazard.

If unforeseeable residual dangers occur, the operation of the machine is to be stopped immediately and the competent supervisor is to be informed. This supervisor shall make the following decisions and initiate everything required to eliminate the occurring danger.

If necessary, the machine manufacturer is to be informed.

### **3.6 General safety instructions**

The safety instructions in this chapter include the "General Safety Instructions", which should be reported in the manual in accordance with the applicable standards. There may be information that is not relevant to this machine.

#### **3.6.1 Working area**

- Before beginning work, familiarize yourself with the working environment, e.g. the load-bearing capacity of the floor or obstacles in the vicinity.
- Make working area safe for the public transport sector.
- Necessary fuse protection of walls and ceilings, e.g. in trench applications.
- Keep the working area tidy. Cluttered or dark working areas can lead to accidents.
- Using this machine in an explosive atmosphere is prohibited.
- When using this machine, children and unauthorized individuals must be kept away. Distraction can lead to loss of control of the machine.
- Always protect the machine against tilting, rolling, sliding, and crashing. Risk of injury!

#### **3.6.2 Service**

- The machine should only be maintained/repaired by technically trained personnel.
- Use only original spare parts and accessories. This ensures the operational safety of the machine.

#### **3.6.3 Personal safety**

- Working under the influence of drugs, alcohol, or drugs can lead to serious injuries.



- Protective equipment should be worn for all work. Appropriate personal protective equipment considerably reduces the risk of injury.
- Remove any tools before the machine is put into operation. Tools that are located on a rotating machine part can be ejected and cause serious injury.
- Always ensure good footing.
- In the case of extensive work with this machine, long-term vibration-induced damage cannot be ruled out. For exact values of vibration measurement, refer to the *Technical Data* section.
- Wear suitable clothing. Keep loose clothing, gloves, jewelry, and long hair away from moving/rotating machine parts. Danger of being pulled!
- Ensure that no other individuals are in the danger zone!

### 3.6.4 Handling and use

- Handle machines with care. Do not operate machines with defective components or operator's controls. Immediately replace defective components or operator's controls. Machines with defective components or operator's controls carry a high risk of injury!
- The operator's controls of the machine shall not be improperly locked, manipulated, or changed.
- The machine, accessories, and tools should be used in accordance with these instructions.
- Store unused machines out of reach of children. The machine may only be operated by authorized personnel.
- After operation, store the cooled-down machine in a locked, clean, frost-protected, and dry location that is inaccessible to children and other unauthorized individuals.

## 3.7 Specific safety instructions – Vibratory plates

### 3.7.1 External influences

**In the case of the following external influences, the vibratory plate may not be operated:**

- In heavy rain on sloped surfaces. Risk of slipping!
- Oil field environments – methane leaks from bottom. Explosion hazard!
- In dry, flammable vegetation. Fire hazard!
- In potentially explosive areas. Explosion hazard!

### 3.7.2 Operational safety

- When operating the machine, make sure that no gas, water, or electric lines are damaged.
- The machine must not be operated in tunnels or enclosed spaces.
- Pay maximum attention near drops or slopes. Risk of crashing!
- The operator must not leave the machine while it is in operation.
- Do not leave the machine unattended. Risk of injury!
- Delimit spacious workspace and restrict access to unauthorized individuals. Risk of injury!
- Machine operators must ensure that people in the working area keep a minimum distance of 2 meters from the running machine.
- Do not use any starting aid sprays. These can cause misfires as well as engine damage. Fire hazard!
- Always approach gradients from below when operating the machine on sloped surfaces. The machine could slip or tip over.
- Do not exceed max. allowable slanting position of the machine – possible failure of the engine lubrication, see chapter *Technical Data*.

### 3.7.3 Minimum safety distances

Compaction work near buildings can cause damage to buildings. Therefore, all potential effects and vibrations on surrounding buildings must be checked in advance.

The relevant rules and regulations for measuring, evaluating and reducing vibration emissions - especially the DIN 4150-3 - must be considered.

Wacker Neuson assumes no liability for any damage to buildings.

## 3.8 General safety instructions - Combustion engines

**The following notes must be observed:**

- Before starting work, check the engine to ensure there are no leaks and cracks in the fuel lines, tank and fuel cap.
- Do not operate a defective engine. Replace damaged parts immediately.
- The pre-set engine speed may not be adjusted. This could lead to engine damage.
- Make sure that the exhaust system of the engine is free of debris. Fire hazard!





- Switch off the engine and allow to cool before refueling.
- Use the correct fuel type. The fuel may not be mixed with other liquids.
- Use clean filling aids for refueling. Do not spill fuel. Immediately wipe up any spilled fuel.
- The engine may not be started near spilled fuel. Explosion hazard!
- For operation in partially closed spaces, sufficient ventilation and aeration must be ensured. Do not inhale exhaust fumes. Risk of poisoning!
- The engine surface and exhaust system can quickly become extremely hot. Risk of burns!

---

**NOTICE**

This machine is outfitted with an EPA-certified engine.

Adjusting the revolutions per minute (RPM) impacts the EPA-certification and the emissions. Settings for this engine may only be changed by a professional.

For more information, contact the manufacturer or your Wacker Neuson contact partner.

---

### 3.9 General safety instructions – fuel, lubricants and coolants

The following notes must be observed:

- Always wear safety glasses and protective gloves when handling fuel, lubricants, and coolants. If hydraulic oil, fuel, oil, or coolant gets into your eyes, see a doctor immediately.
- Avoid direct skin contact with fuel, lubricants and coolants. Immediately rinse skin with soap and water.
- Do not eat or drink while working with fuel, lubricants and coolants
- Contaminated hydraulic oil or fuel from dirt or water can lead to premature wear or failure of the machine.
- Dispose of spilled fuel, lubricants and coolants according to the applicable provisions for environmental protection.
- If fuel, lubricants and coolants escape from the machine, do not operate the machine any longer and have it repaired immediately by the Wacker Neuson contact partner.

### 3.10 Maintenance

The following notes must be observed:

- This machine may not be maintained, repaired, adjusted or cleaned while switched on.
- Adhere to maintenance intervals.
- After each maintenance or repair, the safety devices on this machine must be reattached.
- Observe the maintenance schedule. Non-listed work must be taken over by the service department of the Wacker Neuson contact partner.
- Immediately replace worn or damaged machine parts. Only use spare parts from Wacker Neuson.
- Keep the machine clean.
- Missing, damaged, or illegible safety warning labels should be replaced immediately. Safety stickers contain important information for the protection of the operator.
- Maintenance jobs must be performed in a clean and dry vicinity (e.g. workshop).

### 3.11 Personal Protective Equipment



---

**NOTICE**

To prevent personal injury when handling this machine, personal protective equipment must be worn when working on or around this machine.

---



Pictogram	Significance	Description
	Wear safety shoes!	Safety shoes provide protection from bruises, falling objects, and slipping.
	Wear protective gloves!	Protective gloves provide protection from abrasion, cuts, punctures, and hot surfaces.
	Wear ear protection!	Ear protection provides protection from permanent hearing impairment.

**NOTICE**

With this machine, the permissible, country-specific noise limit (personal rating level) may be exceeded. Therefore, ear protection must be worn. For exact values regarding noise emissions, refer to *Technical Data* section.

Work particularly cautiously and pay attention when wearing ear protection, as your ability to hear noises, such as screams or signal tones, is restricted.

Wacker Neuson recommends always wearing ear protection.

**3.12 Safety devices**

Safety devices protect the user of this machine from being exposed to existing hazards. These are barriers (separating protective devices) or other technical measures. This prevents the user from being exposed to a danger. The source of danger will be eliminated in certain situations or the danger will be reduced.

This machine has the following safety equipment:

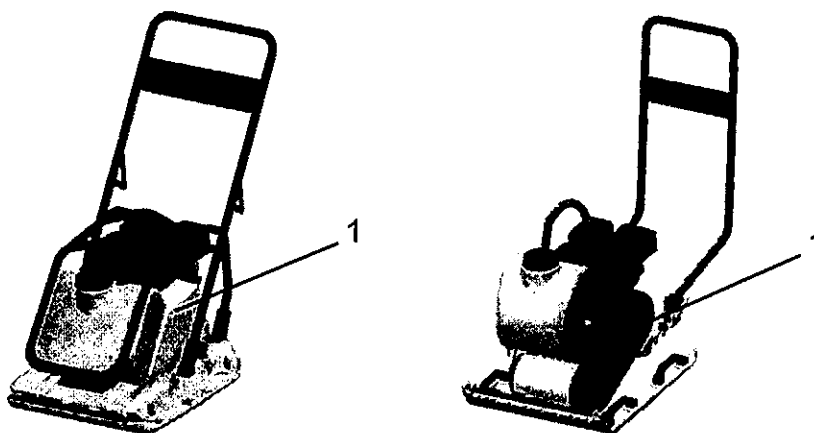

Item	Description
1	Belt guard



---

**NOTICE**

Always tighten loosened screwed connections with the prescribed torque setting.

---

**3.13 Behavior in dangerous situations**

**Preventive measures:**

- Always be prepared for accidents.
- Keep first aid equipment on hand.
- Make sure that all employees are familiar with accident reporting, first aid, and rescue facilities.
- Keep access routes clear for emergency vehicles.
- Make sure that employees receive first aid training.

**Measures in the case of an emergency:**

- Immediately take the machine out of operation.
- Remove injured and other people from the danger zone.
- Initiate first aid measures.
- Alert rescuers.
- Keep access routes clear for emergency vehicles.
- Inform the person responsible at the site of application.



## 4 Safety and information labels



### WARNING

Illegible symbols





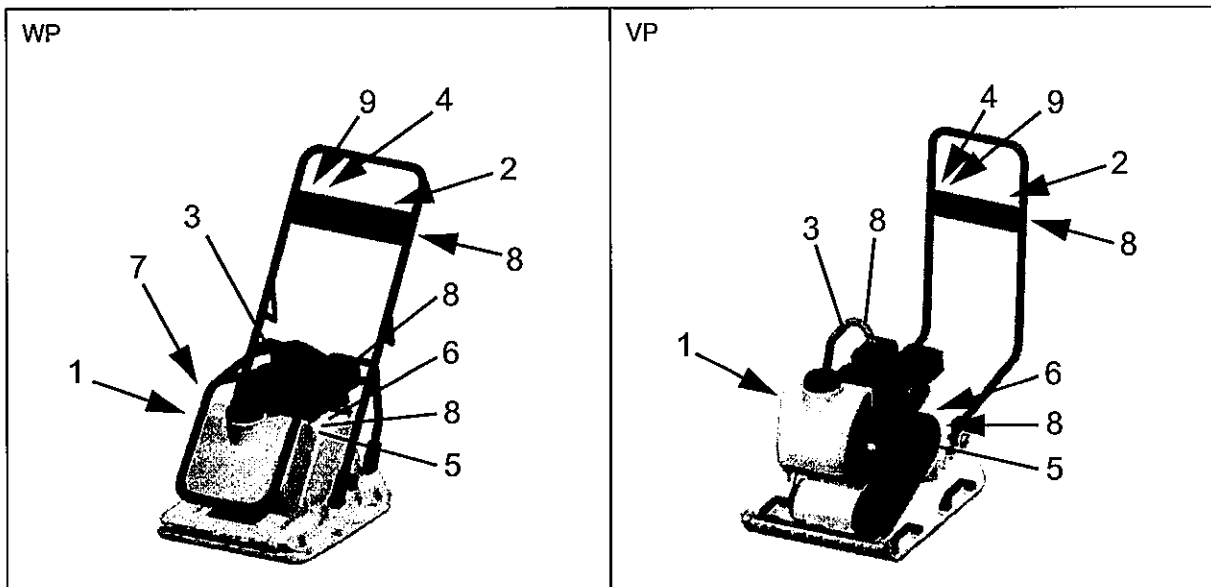

Over time, labels and signs on the machines can become dirty or otherwise unrecognizable.

- Keep all safety, warning, and operating instructions on the machine in a legible condition.
- Replace damaged labels and signs immediately.

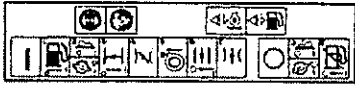
The following labels are located on the machine:



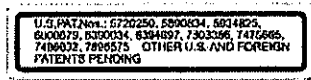
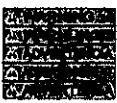

Item	Label	Description
1		Start/Stop.
2		Use personal protection equipment in order to prevent injuries and health hazards. <ul style="list-style-type: none"> <li>■ Ear protection.</li> <li>■ Read operator's manual.</li> <li>■ Start/Stop description.</li> </ul>
3		Falling machines can cause serious injury. <ul style="list-style-type: none"> <li>■ Only lift machine at the central lifting point with certified lifting gear and tackle (safety load hook).</li> <li>■ Do not lift the machine on the central lifting point with an excavator bucket.</li> </ul>
4		Falling machines can cause serious injury. <ul style="list-style-type: none"> <li>■ Do not lift the machine at the control handle.</li> </ul>
5		Flames are prohibited.
6		Guaranteed sound power level.
7		Patent pending.
8	US Machines 	Warning.
9	US Machines 	Danger.



## 5 Setup and function

### 5.1 Standard package

The standard package includes:

- Vibratory plate
  - The control handle is included separately for the vibratory plate WP.
  - The vibratory plate VP is complete.
- Operator's manual

### 5.2 Application areas

The vibratory plate is used for compacting soil. It is used in gardening and landscaping as well as civil engineering, road construction, and paving.

### 5.3 Short description

The vibratory plate is a machine used to compact soils.

The vibration required for the compaction is generated by the exciter firmly connected to the base plate. This exciter is designed as a single directional, front mounted exciter with circular vibrations.

The drive motor attached to the engine console drives the exciter. The torque is firmly transferred through the centrifugal clutch and the exciter V-belt.

At low engine speeds, the centrifugal clutch interrupts the force flow to the exciter and thereby allows a flawless idling of the drive motor. The revolutions per minute (RPM) of the drive motor can be changed at the throttle lever from full throttle to idling and to stop.

The engine console and base plate are connected to each other through 4 vibration-absorbing rubber metal buffers. This damping prevents a transfer of the very high frequencies to the engine console. The functionality of the drive motor therefore remains preserved, despite the high compaction performance.

The drive motor works through a recoil starter, draws the combustion air through a dry-type air cleaner and is air-cooled.

### 5.4 Versions

This operator's manual covers the following models:

Versions	Description
W	Water tank



## 6 Components and operator's controls

### 6.1 Components

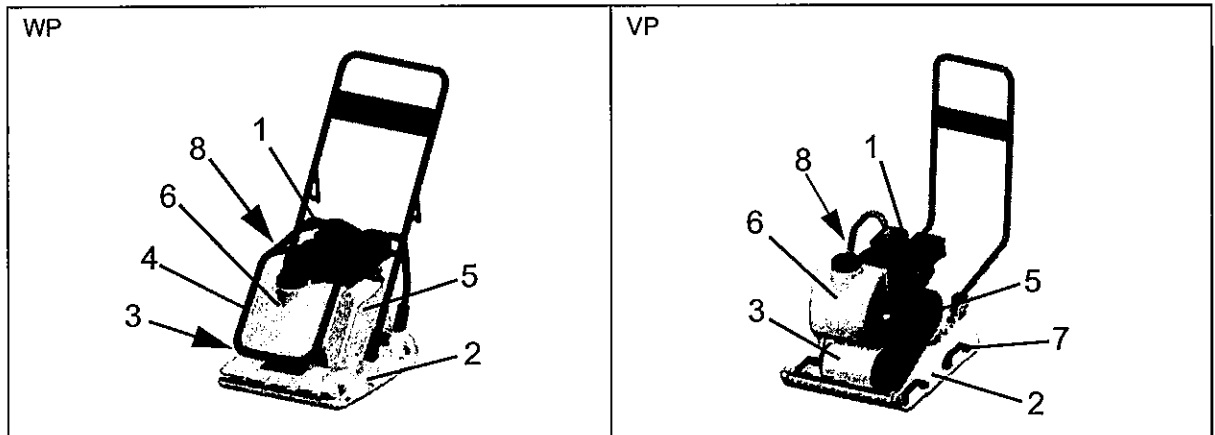

Item	Designation	Item	Designation
1	Drive motor	5	Belt guard
2	Base plate	6	Water tank (optional)
3	Exciter	7	Handle grip (VP)
4	Protective frame (WP)	8	Nameplate

### 6.2 Operator's controls

Always keep the display and operator's controls on the machine clean, dry, and free of oil and grease. Operator's controls, such as the ON/OFF switch, throttle control handles, etc. may not be locked, manipulated or changed without permission.

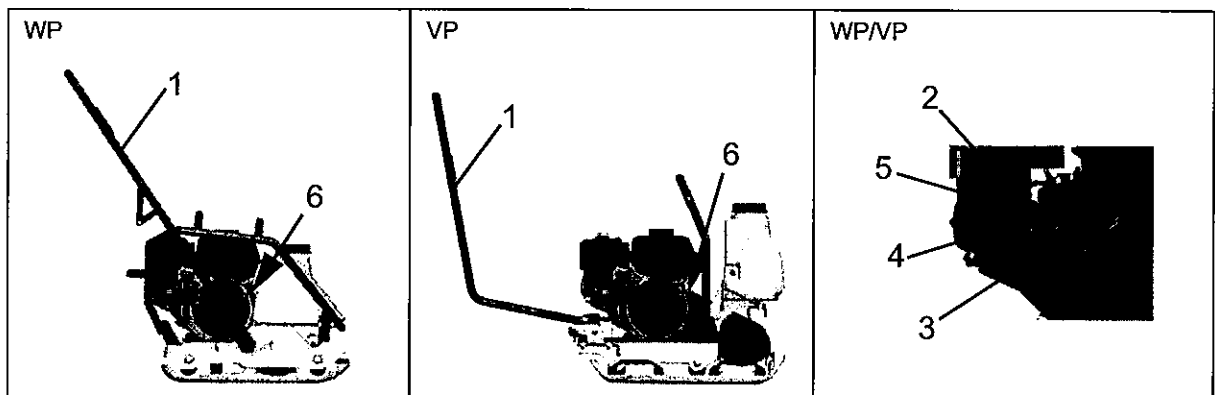

Item	Designation	Item	Designation
1	Control handle	4	Fuel cock
2	Throttle lever	5	Choke lever
3	Handle recoil starter	6	Engine switch



## 7 Transport



### WARNING

Improper handling may result in injury or serious material damage.

- Please read and follow all safety instructions in this operator's manual.



### DANGER

Danger from falling.

Falling machines can cause serious injury e.g. through crushing.

- Only use suitable and tested lifting gear and tackle (safety load hooks) of sufficient lifting capacity.
- Only lift the machine from the central lifting point.
- Reliably secure the machine to the lifting gear.
- Do not lift the machine with a crane by the control handle and handle grip.
- Evacuate danger zone while lifting, do not stop under suspended loads.



### WARNING

Risk of fire and explosion from fuel.

Escaping fuel may catch fire and cause serious burns.

- Lift and transport the machine upright.

### 7.1 Loading and transport

#### Previous conditions

- To transport the vibratory plate, only use suitable lifting gear with a minimum load-bearing capacity of 150 kg.
- Always switch off the engine during transport!
- Attach suitable tackle to the intended central lifting point.

#### Carry out preparations

### NOTICE

Wacker Neuson recommends emptying the fuel tank prior to transport.

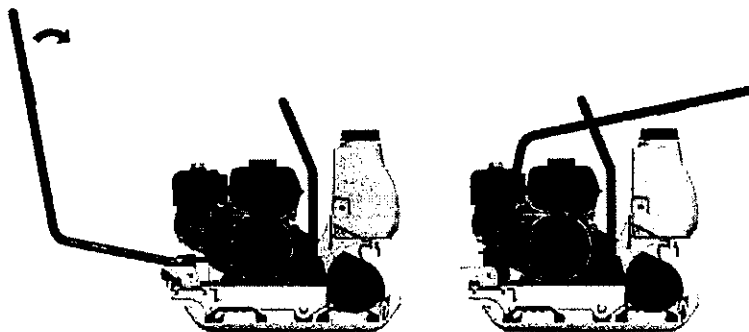

During loading and transport, the control handle must be folded down.





**Lifting and lashing down the machine**

**NOTICE**

Appoint a specialist flagman for a safe lifting operation.

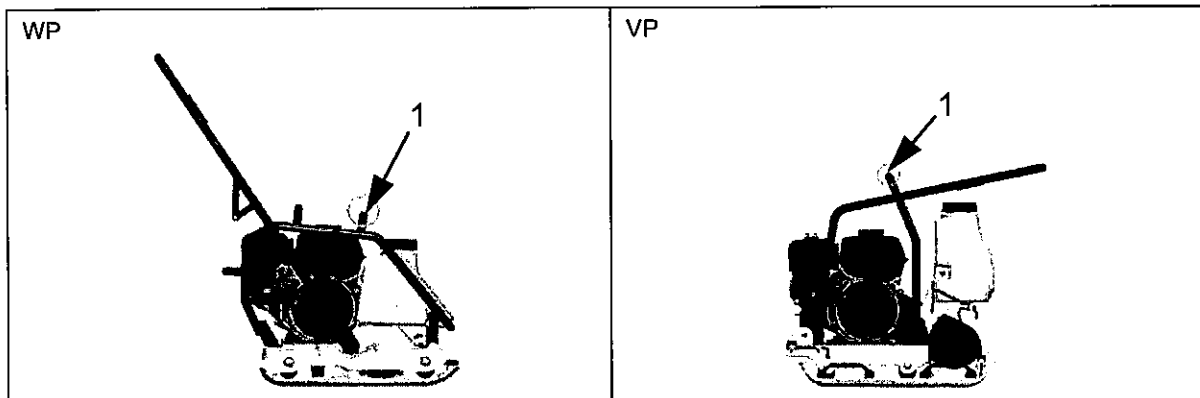

Item	Designation
1	Central lifting point

1. To lift the machine, hang suitable tackle at the central lifting point.
2. Carefully load machine into or onto a stable means of transport.

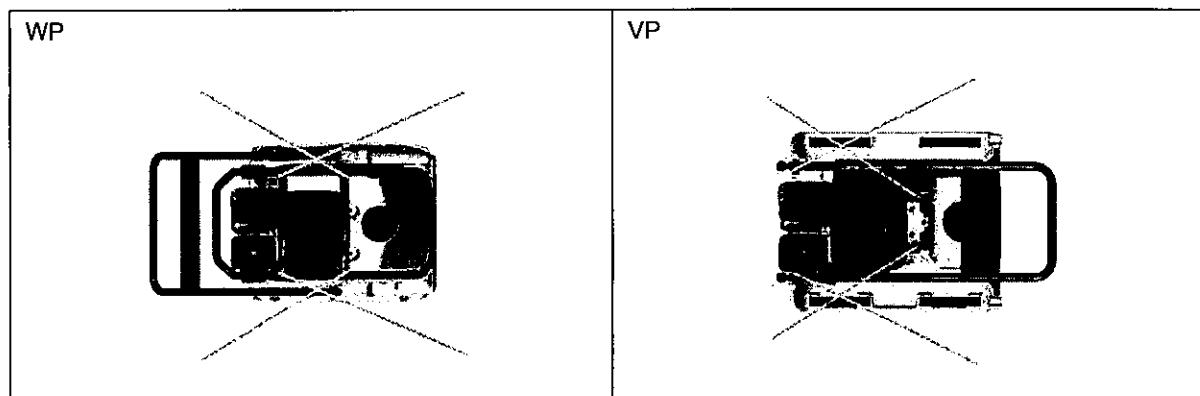

3. After loading the machine, lash down the machine to prevent it from rolling off, slipping, or tipping over. Attach tie-down lugs to the designated lashing points.



## 8 Operation and use



### WARNING

Improper handling may result in injury or serious material damage.

- Please read and follow all safety instructions in this operator's manual.

### 8.1 Initial operation

#### 8.1.1 WP

The supplied control handle needs to be attached prior to initial operation.

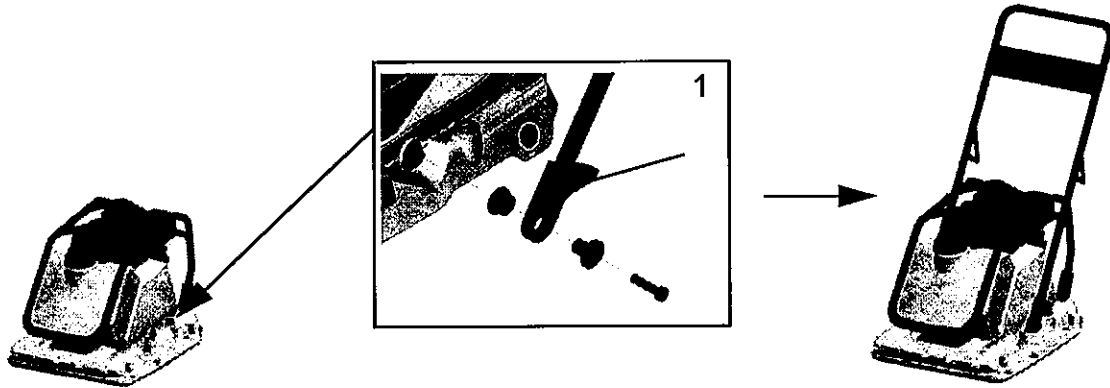

Item	Designation
1	Control handle

1. Align the control handle on the provided bores.
2. Tighten the control handle on the left and right with the screws. The torque setting is 86 Nm.

#### 8.1.2 VP

The machine is delivered fully assembled and is ready for operation out of the box.

### 8.2 Before commissioning

#### 8.2.1 Inspection before commissioning

- Check the machine and components for damage. In the event of visible damage, do not operate the machine and immediately contact Wacker Neuson service.
- Ensure that loose packaging material has been removed from the machine.
- Check the fuel level.
- Check the engine oil level.
- Check the fuel lines for leak tightness.
- Check to ensure the screwed connections are firmly seated.

### NOTICE

Perform control procedures according to the *Maintenance* chapter. If necessary, top off missing fuel, lubricants and coolants, see chapter *Technical Data*.

### 8.3 Notes about operation



### WARNING

Danger of tipping

There is a serious risk of injury from slipping or tipping over of the machine.

Near edges, at least 2/3 of the machine must be on a load-bearing surface.

- Turn off the machine and lift it back onto a load-bearing surface.



**WARNING**

Health hazard from exhaust fumes

- The exhaust fumes of this engine contain chemicals, which the state of California knows can cause cancer, birth defects or other reproductive damage.

**Operation on sloped surfaces**

- Only approach gradients from below (a gradient that can be easily driven up can also be driven down without any risk).
- Do not exceed the maximum allowable slanting position (see *Technical Data*) chapter.
- Only operate the machine for a short time in maximum allowable slanting position.

**NOTICE**

If the maximum permissible slanting position is exceeded, this results in a failure of the engine lubrication and therefore inevitably causes a defect of important engine parts.

**Soil properties**

- The maximum dumping height depends on several factors of the soil properties, such as moisture, particle-size, etc.  
It is therefore not possible to provide an exact specification for this value.  
**Recommendation:** In each case, determine the maximum dumping height through compaction tests and soil samples.

**Vibrating sett paving (paving stones)**

When compacting interlocking paving stones, Wacker Neuson recommends the application of the sliding mechanism in order to avoid damage to the machine and compaction material. See chapter *Accessories*.

**8.4 Commissioning**



**DANGER**

Fire hazard

Jumper cable sprays are highly flammable; they can ignite and cause severe burns.

- Do not use jumper cable sprays.

1. Push the fuel cock to the right to open.

**NOTICE**

If the engine is cold, close the choke lever. If the engine is warm, open the choke lever.

2. Put the engine switch in the ON position.
3. Open the throttle lever slightly to the left.
4. Pull the starter rope.

**NOTICE**

If the oil level is too low, the engine will not start and the oil needs to be filled. Some models are equipped with a low oil warning light that will light up red when pulling the starter rope.

5. Open the choke lever while the engine is warming up.
6. Fully open the throttle lever to operate.



## 8.5 Operation

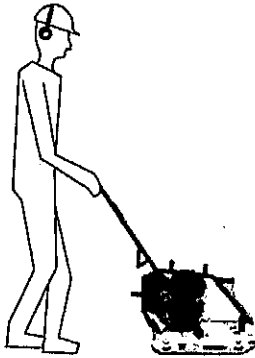

- In accordance with the intended purpose, the operator should stand behind the machine.
- Guide and steer the machine using the control handle.

## 8.6 Decommissioning

1. Push the throttle lever to the right until it stops and bring the RPM to idling.
2. Put the engine switch in the OFF position.
3. Push the fuel cock to the left to close.



## 9 Maintenance



**WARNING**

Improper handling may result in injury or serious material damage.

- Please read and follow all safety instructions in this operator's manual.



**WARNING**

Danger of poisoning from exhaust fumes.

Exhaust fumes contain poisonous carbon monoxide, which can lead to unconsciousness or to death.

- Only perform maintenance jobs with the engine switched off and the machine decommissioned.



**WARNING**

Risk of injury from uncontrolled starting of the machine and moving parts.

- Only perform maintenance jobs with the engine switched off and the machine decommissioned.



**WARNING**

Risk of fire and explosion from fuel and fuel vapors.

Fuel and fuel vapors may ignite or catch fire and cause serious burns.

- Do not smoke.
- Do not refuel near open flames.
- Switch off the engine and allow to cool before refueling.



**WARNING**

Warning of hot surfaces

The exhaust system and engine can become extremely hot, which can lead to severe skin burns.

- Always allow the engine to cool down completely after use.
- If the cool-down phase cannot be adhered to (e.g. due to an emergency), use heat-resistant protective gloves.



**WARNING**

Risk of injury due to non-existent or non-functioning safety devices.

- Only operate the machine if the safety devices are properly fixed and functioning.
- Do not modify or remove safety devices.



**9.1 Maintenance table**

Maintenance jobs	Daily	h/year	Weekly	Monthly
Clean the machine Visual inspection for completeness Visual inspection for damage	■			
Check the engine oil level*	■			
Check the intake area of the combustion air*	■			
Check the to ensure the screwed connections are firmly seated	■			
Clean the fuel sieve cup	■			
Replace the engine oil*		20 h/100 h		
Check the tapped clearance**		300 hours		
Check the spark plugs **		100 hours		
Check the rubber buffer**		125 hours		
Replace the exciter oil**		250 hours		
Replace the fuel filter*		500 hours		
Clean the air cleaner cartridge*				■
Check water trap*			■	
Check the exciter oil level		150 hours		■
Retention/replace the V-belt				■
* Note the engine operator's manual. ** Have this work performed by the service department of your Wacker Neuson contact partner.				

**9.2 Maintenance jobs**



**CAUTION**

Health risk from fuel, lubricants and coolants.

- Do not inhale fuel, lubricants, coolants or vapors.
- Avoid contact of skin or eyes with fuel, lubricants and coolants.



**WARNING**

Risk of fire and explosion from fuel and fuel vapors.

- Do not smoke.
- Do not refuel near open flames.
- Switch off engine and allow to cool before refueling. Only refuel in a well-ventilated vicinity.

**Carry out preparations**

1. Place the machine on a level surface.
2. Decommissioning the machine.
3. Allow engine to cool down.



**Check the fuel level and top off**

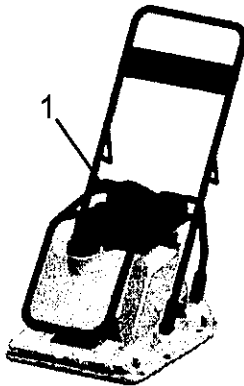

Item	Designation
1	Fuel cap

1. Remove dirt accumulation within the range of the fuel filler neck.
2. Open the fuel cap.
3. Check the fuel level by visual inspection.
4. If necessary, top off the fuel with a clean filling container.
5. Fuel type See chapter *Technical Data*.

**NOTICE**

Only fill the fuel tank to the bottom edge of the filler neck.

6. Tightly close the fuel cap.

**Clean the sediment cup**

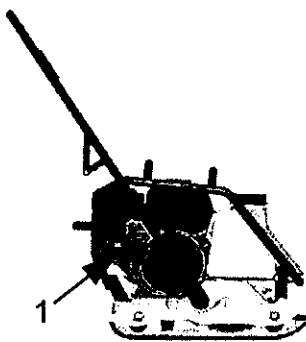

Item	Designation
1	Sediment cup

1. Shut off the fuel cock.
2. Remove the sediment cup and O-ring, wash in a cleaning solution and dry thoroughly.
3. Insert the sediment cup and O-ring.
4. Turn on the fuel cock and check for leaks.

**Clean the machine**



**WARNING**

Risk of fire and explosion when using flammable cleaning agents.

- Do not clean the machine and elements with gasoline or other solvents.

**NOTICE**

Penetrating water can damage the engine, electrical operator's controls or components of the machine. Do not aim high pressure washer directly at air intake area and electrical elements.

1. After cleaning, check the cable, hoses, utility lines and hardware for leaks, loose connections, chafe marks and other damage.
2. Immediately eliminate detected damage.

**Screwed connections**

For the vibratory plates, the screwed connections must be regularly checked for a firm seat.

**Check engine oil level**

**NOTICE**

The machine needs to be decommissioned and level when checking the oil level and changing the oil.

1. Check the oil level on the oil-level dipstick and top off if necessary. For the motor oil type, see chapter *Technical Data*.

**Replace motor oil**



**DANGER**

Risk of scalding

- Use caution when draining hot oil.

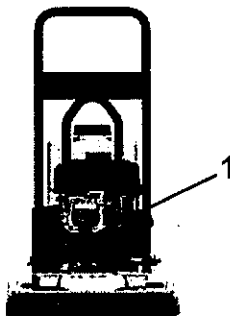

Item	Designation
1	Oil-level dipstick / filler neck

**NOTICE**

Drain the oil when the engine is still warm.

**NOTICE**

Lay an impermeable film on the working surface to protect against escaping oil.





1. Remove the cover from the filler neck.
2. Loosen the oil drain hose (VP) for draining the oil and collect the draining oil in a suitable bin.
3. Reattach the oil drain hose (VP).

**NOTICE**

Collect escaping or overflowing oil and dispose of with the waste oil in an environmentally friendly manner in accordance with the existing rules and regulations of the legislative body.

4. Fill new oil (see chapter *Technical Data* for the motor oil type and volume) in the filler neck. Use an appropriate and clean filling container.
5. Check the oil level on the oil-level dipstick and top off if necessary.
6. Close the cover of the filler neck.

**Retention/replace the exciter V-belt**

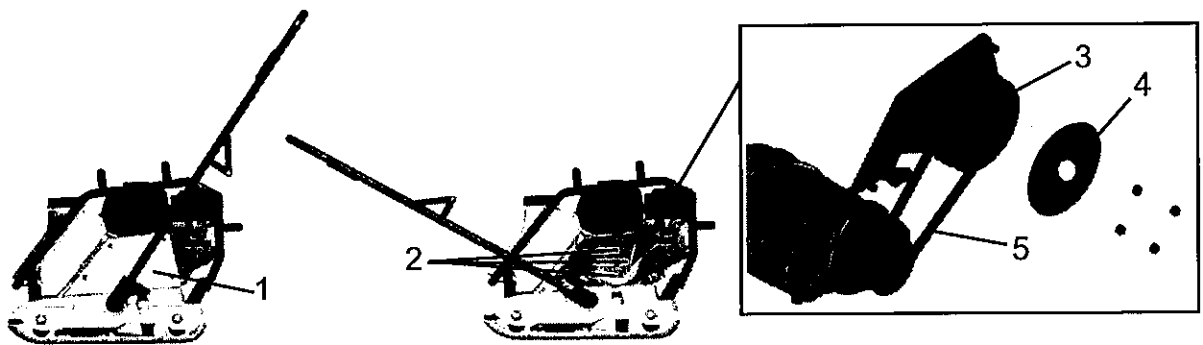

Item	Designation	Item	Designation
1	Belt guard	4	V-belt pulley half
2	Nuts	5	V-belt
3	Engine V-belt pulley		

1. Fold the control handle to the front.
2. Disassemble the belt guard.
3. Loosen the nuts on the engine V-belt pulley and remove the outer v-belt pulley half.
4. Remove the required number of shims (removing one shim usually suffices).
5. Affix the v-belt pulley half.
6. Attach the removed shims on the outsides of the v-belt pulley half and tighten with the nuts with 25 Nm.

**NOTICE**

Turn the v-belt pulley half here in order to avoid a pinching of the v-belt.

---

**Replace the exciter oil for vibratory plate VP**

---

**DANGER**

Risk of scalding

- Use caution when draining hot oil.
- 

**NOTICE**

Perform oil change with warm exciter oil. The machine cannot be in operation.



Item	Designation
1	Screw plug for filler boring

---

**NOTICE**

Lay an impermeable film on the working surface to protect against escaping oil.

1. Tip the machine to the side of the filler boring and support it.
  2. Place an appropriate collecting container below the filler boring.
  3. Remove dirt accumulation within the range of the filler boring.
  4. Unscrew the screw plug from the filler boring and allow the waste oil to drain completely.
- 

**NOTICE**

Collect escaping or overflowing oil and dispose of with the waste oil in an environmentally friendly manner in accordance with the existing rules and regulations of the legislative body.

5. Tip the machine to the other side and support it.
- 

**NOTICE**

Only fill with the prescribed volume of oil.

6. Fill new oil (see chapter *Technical Data* for the exciter oil type and volume) in the filler boring. Use an appropriate and clean filling container.
  7. Screw the screw plug with seal ring into the filler boring. The torque setting is 25 Nm.
-



**Replace the exciter oil for vibratory plate WP**



**DANGER**

Risk of scalding

- Use caution when draining hot oil.

**NOTICE**

Perform oil change with warm exciter oil. The machine cannot be in operation.

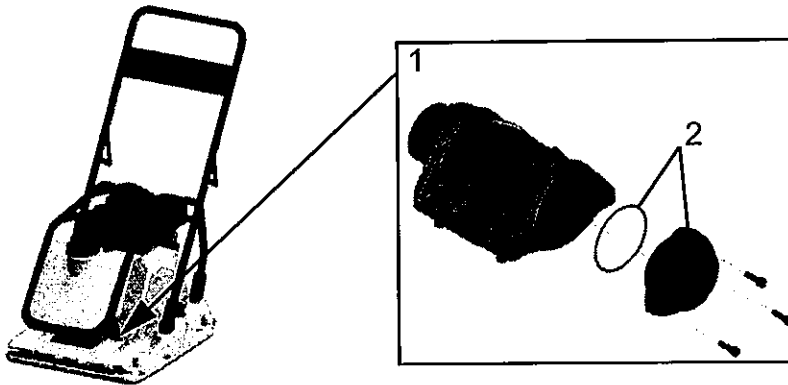

Item	Designation	Item	Designation
1	Exciter	2	Side cover with O-ring

**NOTICE**

Lay an impermeable film on the working surface to protect against escaping oil.

1. Remove the belt guard and V-belt. See chapter *Re-tension / replace exciter V-belt*.
2. Loosen and remove the screws of the upper and base plate.
3. Loosen the screws of the exciter and remove the exciter.
4. Loosen the side cover of the exciter and remove with the O-ring.
5. Tilt the exciter on its side and allow the rest of the waste oil to drain. Collect the waste oil with a suitable bin.

**NOTICE**

Collect escaping or overflowing oil and dispose of with the waste oil in an environmentally friendly manner in accordance with the existing rules and regulations of the legislative body.

6. Check the exciter housing for sediments and clean if necessary.
7. Fill new oil (see chapter *Technical Data* for the exciter oil type and volume). Use an appropriate and clean filling container.
8. Set up the side cover of the exciter with the O-ring and tighten. The torque setting is 25 Nm.
9. Attach the upper and base plate. The torque setting is 38 Nm.
10. Attach the V-belt and belt guard. See chapter *Re-tension / replace the exciter V-belt*.

---

Cleaning the air cleaner

---



**WARNING**

**Risk of fire and explosion!**

- Do not use any gasoline or cleaning solution to clean the air cleaner cartridge.
- 



**CAUTION**

Do not run the engine without an air cleaner. This will quickly lead to engine wear.

---

1. Remove the wing nuts and air cleaner cover.
2. Remove and separate the air cleaner cartridge.
3. Check both applications for holes and cracks and replace if damaged.

---

**NOTICE**

**Foam insert:**

Wash out the insert in a solution of household detergent and warm water and then rinse thoroughly. Allow the insert to dry and tip into clean motor oil. Press out excessive oil. If too much oil remains in the insert, the engine will smoke during its first start.

---

---

**NOTICE**

**Paper insert:**

Gently tap the insert several times against a hard surface to remove excess grime. Blow compressed air from the inside to the outside through the filter. Do not brush the dirt off as it will get pressed into the fibers.

In the event of extreme dirt accumulation, replace the insert.

---



## 10 Troubleshooting



**DANGER**

Danger to life from unauthorized troubleshooting.

- If faults occur with this machine that are not described in this manual, contact the manufacturer. Do not eliminate the faults independently.

### 10.1 Fault table

<b>Fault</b>	<b>Possible causes</b>	<b>Remedial measure</b>
Motor will not start.	Engine switch in the OFF position.	Put the engine switch in the ON position.
	Throttle lever in the stop or idling position.	Place the throttle lever in the start position.
	Not enough fuel.	Refuel. Check the fuel supply and filter.
	Wrong tapped clearance.	Check the tapped clearance, adjust if necessary.*
	Worn valves.	Have the machine repaired.*
	Cylinder and/or piston ring wear.	
Worn spark plugs.		
No vibration with running engine.	Worn V-belt.	Replace V-belt.
	Worn clutch lining.	Replace clutch lining.*
* Have this work performed by the service department of your Wacker Neuson contact partner.		



---

## 11 Accessories



### **CAUTION**

Accessories and spare parts that do not originate from Wacker Neuson can increase the risk of injury and possible damage to the machine.

- The use of other accessories and spare parts that do not originate from Wacker Neuson shall cancel any liability.

---

A wide range of accessories is offered for the machine.

More information about the individual accessories can be found online at [www.wackerneuson.com](http://www.wackerneuson.com).

### **Sliding mechanism**

Sliding mechanisms offer optimal protection against damage to the sett paving (paving stone) surface, which is especially required for surface-coated types of paving.

### **Water tank**

For the processing of asphalt, it is recommended to retrofit the vibratory plate with a water tank with an efficient sprinkler system. The variably adjustable sprinkler system prevents cracking and adhesion to the asphalt.

### **Transport device**

A transport device is offered for easier transport on the job site.

**12 Technical data****12.1 WP1540**

Designation	Unit	WP1540A	WP1540A US	WP1540Aw	WP1540Aw US
Item number		5100018330	5100018328	5100018329	5100018327
Centrifugal force	kN	15.0	15.0	15.0	15.0
Oscillations	Hz	98	98	98	98
	1/min	5,880	5,880	5,880	5,880
Compaction performance*	m <sup>2</sup> /h	697	697	697	697
Travel speed	m/min	27.0	27.0	27.0	27.0
Gradeability	%	36.4	36.4	36.4	36.4
Length (center pole in working position)	mm	877	877	877	877
Width	mm	430	430	430	430
Height	mm	961	961	961	961
Operating weight	kg	87.0	87.0	93.0	93.0
Ground clearance	mm	525	525	525	525
Rated power**	kW	3.6	3.6	3.6	3.6
Nominal speed	1/min	3,600	3,600	3,600	3,600
Exciter oil volume	l	0.15	0.15	0.15	0.15
Exciter oil type		M 75W-90	M 75W-90	M 75W-90	M 75W-90
Storage temperature range	°C	-15--+40	-15--+40	-15--+40	-15--+40
Operating temperature range	°C	-15--+40	-15--+40	-15--+40	-15--+40
Sound pressure level At location of operation L <sub>pA</sub>	dB(A)	94	94	94	94
Standards		EN 500-4			
Sound power level L <sub>wa</sub> measured guaranteed	dB(A)	107	107	107	107
		108	108	108	108
Standards		EN 500-4			
Vibration total value a <sub>hv</sub>	m/s <sup>2</sup>	5.3	5.3	5.3	5.3
Standards		EN 500-4			
Uncertainty of measurement of the vibration total value a <sub>hv</sub>	m/s <sup>2</sup>	0.5	0.5	0.5	0.5
* Depending on the soil properties.					
** Corresponds to the net installed power according to directive 2000/14/EC.					

**12.2 WP1550**

Designation	Unit	WP1550A	WP1550A US	WP1550Aw	WP1550Aw US
Item number		5100018323	5100018325	5100016241	5100018324
Centrifugal force	kN	15.0	15.0	15.0	15.0
Oscillations	Hz	98	98	98	98
	1/min	5,880	5,880	5,880	5,880
Compaction performance*	m <sup>2</sup> /h	750	750	750	750
Travel speed	m/min	25.0	25.0	25.0	25.0
Gradeability	%	36.4	36.4	36.4	36.4
Length (center pole in working position)	mm	877	877	877	877
Width	mm	498	498	498	498
Height	mm	963	963	963	963
Operating weight	kg	91.0	91.0	97.0	97.0
Ground clearance	mm	527	527	527	527
Rated power**	kW	3.6	3.6	3.6	3.6
Nominal speed	1/min	3,600	3,600	3,600	3,600
Exciter oil volume	l	0.15	0.15	0.15	0.15
Exciter oil type		M 75W-90	M 75W-90	M 75W-90	M 75W-90
Storage temperature range	°C	-15--+40	-15--+40	-15--+40	-15--+40
Operating temperature range	°C	-15--+40	-15--+40	-15--+40	-15--+40
Sound pressure level At location of operation L <sub>pA</sub>	dB(A)	94	94	94	94
Standards		EN 500-4			
Sound power level L <sub>wa</sub> measured guaranteed	dB(A)	107	107	107	107
		108	108	108	108
Standards		EN 500-4			
Vibration total value a <sub>hV</sub>	m/s <sup>2</sup>	5.3	5.3	5.3	5.3
Standards		EN 500-4			
Uncertainty of measurement of the vibration total value a <sub>hV</sub>	m/s <sup>2</sup>	0.5	0.5	0.5	0.5
* Depending on the soil properties.					
** Corresponds to the net installed power according to directive 2000/14/EC.					



**12.3 Combustion engine**

<b>Designation</b>	<b>Unit</b>	
Manufacturer		Honda
Type of engine		GX160
Combustion method		Four-cycle
Cooling		Air cooling
Cylinders		1
Displacement	cm <sup>3</sup>	163
Max. slanting position	°	20
Fuel type		Gasoline
Fuel consumption	l/h	0.8
Tank capacity	l	3.6
Oil specification		SAE 10W-30
Max. oil filling	l	0.6
Max. performance	kW	3.6
Speed	1/min	3,600
Standards		SAE J1349
Spark plug model		NGK BP-6 ES
Spark plug air gap	mm	0.7 - 0.8
Starter type		Recoil starter



## 13 Technical data

### 13.1 VP1135

Designation	Unit	VP1135A	VP1135A US	VP1135Aw	VP1135Aw US
Item number		5100018353	5100018351	5100018352	5100018350
Centrifugal force	kN	11.0	11.0	11.0	11.0
Oscillations	Hz	98	98	98	98
	1/min	5,880	5,880	5,880	5,880
Compaction performance*	m <sup>2</sup> /h	575	575	575	575
Travel speed	m/min	27.0	27.0	27.0	27.0
Gradeability	%	36.4	36.4	36.4	36.4
Length (center pole in working position)	mm	947	947	947	947
Width	mm	355	355	355	355
Height	mm	872	872	872	872
Operating weight	kg	64.0	64.0	72.0	72.0
Ground clearance	mm	471	471	471	471
Rated power**	kW	2.6	2.6	2.6	2.6
Nominal speed	1/min	3,600	3,600	3,600	3,600
Storage temperature range	°C	-15--+40	-15--+40	-15--+40	-15--+40
Operating temperature range	°C	-15--+40	-15--+40	-15--+40	-15--+40
Sound pressure level At location of operation L <sub>pA</sub>	dB(A)	93	93	93	93
Standards		EN 500-4			
Sound power level L <sub>wa</sub> measured guaranteed	dB(A)	104	104	104	104
		105	105	105	105
Standards		EN 500-4			
Vibration total value a <sub>hV</sub>	m/s <sup>2</sup>	5.3	5.3	5.3	5.3
Standards		EN 500-4			
Uncertainty of measurement of the vibration total value a <sub>hV</sub>	m/s <sup>2</sup>	0.5	0.5	0.5	0.5
* Depending on the soil properties.					
** Corresponds to the net installed power according to directive 2000/14/EC.					



13.2 VP1340

Designation	Unit	VP1340A	VP1340A US	VP1340Aw	VP1340Aw US
Item number		5100018349	5100018347	5100018348 5100026775	5100018346
Centrifugal force	kN	13.0	13.0	13.0	13.0
Oscillations	Hz	98	98	98	98
	1/min	5,880	5,880	5,880	5,880
Compaction performance*	m <sup>2</sup> /h	600	600	600	600
Travel speed	m/min	25.0	25.0	25.0	25.0
Gradeability	%	36.4	36.4	36.4	36.4
Length (center pole in working position)	mm	1069	1069	1069	1069
Width	mm	386	386	386	386
Height	mm	893	893	893	893
Operating weight	kg	84.0	84.0	92.0	92.0
Ground clearance	mm	639	639	639	639
Rated power**	kW	3.6	3.6	3.6	3.6
Nominal speed	1/min	3,600	3,600	3,600	3,600
Exciter oil volume	l	0.25	0.25	0.25	0.25
Exciter oil type		M 75W-90	M 75W-90	M 75W-90	M 75W-90
Storage temperature range	°C	-15–+40	-15–+40	-15–+40	-15–+40
Operating temperature range	°C	-15–+40	-15–+40	-15–+40	-15–+40
Sound pressure level At location of operation L <sub>pA</sub>	dB(A)	94	94	94	94
Standards		EN 500-4			
Sound power level L <sub>wa</sub> measured guaranteed	dB(A)	107	107	107	107
		108	108	108	108
Standards		EN 500-4			
Vibration total value a <sub>hv</sub>	m/s <sup>2</sup>	6.2	6.2	6.2	6.2
Standards		EN 500-4			
Uncertainty of measurement of the vibration total value a <sub>hv</sub>	m/s <sup>2</sup>	0.5	0.5	0.5	0.5
* Depending on the soil properties.					
** Corresponds to the net installed power according to directive 2000/14/EC.					

**13.3 VP1550**

Designation	Unit	VP1550A	VP1550A US	VP1550Aw	VP1550Aw US
Item number		5100018345	5100018343	5100018344	5100018342
Centrifugal force	kN	15.0	15.0	15.0	15.0
Oscillations	Hz	98	98	98	98
	1/min	5,880	5,880	5,880	5,880
Compaction performance*	m <sup>2</sup> /h	750	750	750	750
Travel speed	m/min	25.0	25.0	25.0	25.0
Gradeability	%	36.4	36.4	36.4	36.4
Length (center pole in working position)	mm	1070	1070	1070	1070
Width	mm	386	386	386	386
Height	mm	896	896	896	896
Operating weight	kg	93.0	93.0	101.0	101.0
Ground clearance	mm	642	642	642	642
Rated power**	kW	3.6	3.6	3.6	3.6
Nominal speed	1/min	3,600	3,600	3,600	3,600
Exciter oil volume	l	0.25	0.25	0.25	0.25
Exciter oil type		M 75W-90	M 75W-90	M 75W-90	M 75W-90
Storage temperature range	°C	-15--+40	-15--+40	-15--+40	-15--+40
Operating temperature range	°C	-15--+40	-15--+40	-15--+40	-15--+40
Sound pressure level At location of operation L <sub>pA</sub>	dB(A)	94	94	94	94
Standards		EN 500-4			
Sound power level L <sub>wa</sub> measured guaranteed	dB(A)	107 108	107 108	107 108	107 108
Standards		EN 500-4			
Vibration total value a <sub>hV</sub>	m/s <sup>2</sup>	6.6	6.6	6.6	6.6
Standards		EN 500-4			
Uncertainty of measurement of the vibration total value a <sub>hV</sub>	m/s <sup>2</sup>	0.5	0.5	0.5	0.5
* Depending on the soil properties.					
** Corresponds to the net installed power according to directive 2000/14/EC.					



13.4 VP2050

Designation	Unit	VP2050A	VP2050A US	VP2050Aw	VP2050Aw US
Item number		5100018361	5100018359	5100018360	5100018358
Centrifugal force	kN	20,0	20,0	20,0	20,0
Oscillations	Hz	98	98	98	98
	1/min	5,880	5,880	5,880	5,880
Compaction performance*	m <sup>2</sup> /h	750	750	750	750
Travel speed	m/min	25.0	25.0	25.0	25.0
Gradeability	%	36.4	36.4	36.4	36.4
Length (center pole in working position)	mm	1070	1070	1070	1070
Width	mm	386	386	386	386
Height	mm	896	896	896	896
Operating weight	kg	101.0	101.0	109.0	109.0
Ground clearance	mm	642	642	642	642
Rated power**	kW	3.6	3.6	3.6	3.6
Nominal speed	1/min	3,600	3,600	3,600	3,600
Exciter oil volume	l	0.25	0.25	0.25	0.25
Exciter oil type		M 75W-90	M 75W-90	M 75W-90	M 75W-90
Storage temperature range	°C	-15--+40	-15--+40	-15--+40	-15--+40
Operating temperature range	°C	-15--+40	-15--+40	-15--+40	-15--+40
Sound pressure level At location of operation L <sub>pA</sub>	dB(A)	94	94	94	94
Standards		EN 500-4			
Sound power level L <sub>wa</sub> measured guaranteed	dB(A)	107 108	107 108	107 108	107 108
Standards		EN 500-4			
Vibration total value a <sub>hv</sub>	m/s <sup>2</sup>	5.9	5.9	5.9	5.9
Standards		EN 500-4			
Uncertainty of measurement of the vibration total value a <sub>hv</sub>	m/s <sup>2</sup>	0.5	0.5	0.5	0.5
* Depending on the soil properties.					
** Corresponds to the net installed power according to directive 2000/14/EC.					

### 13.5 Combustion engine

Designation	Unit	VP1030, VP1135	VP1340, VP1550, VP2050
Manufacturer		Honda	
Type of engine		GX120	GX160
Combustion method		Four-cycle	Four-cycle
Cooling		Air cooling	Air cooling
Cylinders		1	1
Displacement	cm <sup>3</sup>	118	163
Max. slanting position	°	20	20
Fuel type		Gasoline	Gasoline
Fuel consumption	l/h	1.0	0.8
Tank capacity	l	2.5	3.6
Oil specification		SAE 10W-30	SAE 10W-30
Max. oil filling	l	0.6	0.6
Max. performance	kW	2.6	3.6
Speed	1/min	3,600	3,600
Standards		SAE J1349	SAE J1349
Spark plug model		NGK BP-6 ES	NGK BP-6 ES
Spark plug air gap	mm	0.7 - 0.8	0.7 - 0.8
Starter type		Recoil starter	Recoil starter



## 14 Emission control systems information and warranty

The Emission Control Warranty and associated information is valid only for the U.S.A., its territories, and Canada.

### **Emission control systems warranty statement**

See the *engine owner's manual* for the applicable exhaust and evaporative emission warranty statement.







# WACKER NEUSON

## EC declaration of conformity

### Manufacturer

Wacker Neuson Produktion GmbH & Co. KG, Preußenstraße 41, 80809 München

This declaration of conformity is issued under the sole responsibility of the manufacturer.

### Product

Product	WP1540	WP1550
Product type	Vibratory plate	
Function of product	Soil compaction	
Item number	5100018330, 5100018329	5100018323, 5100016241
Net installed power	3.6 kW	3.6 kW
Measured sound power level	107 dB(A)	107 dB(A)
Guaranteed sound power level	108 dB(A)	108 dB(A)

### Conformity assessment procedure

According to 2000/14/EC (2006-06), Enclosure VIII.

### Appointed body

VDE Prüf- und Zertifizierungsinstitut GmbH, Merianstraße 28, 63069 Offenbach/Main (NB 0366)

### Guidelines and standards

We hereby declare that this product complies with the relevant provisions and requirements of the following guidelines and standards:

2006/42/EC (2009-10), 2000/14/EC (2006-06), 2014/30/EU (2014-02), EN 55012 (2009-07), EN 500-1 (2009-12), EN 500-4 (2011-02)

### Person responsible for technical documents

Robert Rätthsel,  
Wacker Neuson Produktion GmbH & Co. KG, Preußenstraße 41, 80809 München

München, 29.02.2016

Helmut Bauer  
Managing Director



# WACKER NEUSON

## EC declaration of conformity

### Manufacturer

Wacker Neuson Produktion GmbH & Co. KG, Preußenstraße 41, 80809 München

This declaration of conformity is issued under the sole responsibility of the manufacturer.

### Product

Product	VP1030	VP1135
Product type	Vibratory plate	
Function of product	Soil compaction	
Item number	5100018357, 5100018356	5100018353, 5100018352
Net installed power	2.6 kW	2.6 kW
Measured sound power level	104 dB(A)	104 dB(A)
Guaranteed sound power level	105 dB(A)	105 dB(A)

### Conformity assessment procedure

According to 2000/14/EC (2006-06), Enclosure VIII.

### Appointed body

VDE Prüf- und Zertifizierungsinstitut GmbH, Merianstraße 28, 63069 Offenbach/Main (NB 0366)

### Guidelines and standards

We hereby declare that this product complies with the relevant provisions and requirements of the following guidelines and standards:

2006/42/EC (2009-10), 2000/14/EC (2006-06), 2014/30/EU (2014-02), EN 55012 (2009-07), EN 500-1 (2009-12), EN 500-4 (2011-02)

### Person responsible for technical documents

Robert Räthsel,  
Wacker Neuson Produktion GmbH & Co. KG, Preußenstraße 41, 80809 München

München, 29.02.2016

Helmut Bauer  
Managing Director



# WACKER NEUSON

## EC declaration of conformity

### Manufacturer

Wacker Neuson Produktion GmbH & Co. KG, Preußenstraße 41, 80809 München

This declaration of conformity is issued under the sole responsibility of the manufacturer.

### Product

Product	VP1340	VP1550
Product type	Vibratory plate	
Function of product	Soil compaction	
Item number	5100018349, 5100018348, 5100026775	5100018345, 5100018344
Net installed power	3.6 kW	3.6 kW
Measured sound power level	107 dB(A)	107 dB(A)
Guaranteed sound power level	108 dB(A)	108 dB(A)

### Conformity assessment procedure

According to 2000/14/EC (2006-06), Enclosure VIII.

### Appointed body

VDE Prüf- und Zertifizierungsinstitut GmbH, Merianstraße 28, 63069 Offenbach/Main (NB 0366)

### Guidelines and standards

We hereby declare that this product complies with the relevant provisions and requirements of the following guidelines and standards:

2006/42/EC (2009-10), 2000/14/EC (2006-06), 2014/30/EU (2014-02), EN 55012 (2009-07), EN 500-1 (2009-12), EN 500-4 (2011-02)

### Person responsible for technical documents

Robert Rättsel,

Wacker Neuson Produktion GmbH & Co. KG, Preußenstraße 41, 80809 München

München, 29.02.2016

Helmut Bauer  
Managing Director



**WACKER  
NEUSON**

## EC declaration of conformity

### Manufacturer

Wacker Neuson Produktion GmbH & Co. KG, Preußenstraße 41, 80809 München

This declaration of conformity is issued under the sole responsibility of the manufacturer.

### Product

Product	VP2050
Product type	Vibratory plate
Function of product	Soil compaction
Item number	5100018361, 51018360
Net installed power	3.6 kW
Measured sound power level	107 dB(A)
Guaranteed sound power level	108 dB(A)

### Conformity assessment procedure

According to 2000/14/EC (2006-06), Enclosure VIII.

### Appointed body

VDE Prüf- und Zertifizierungsinstitut GmbH, Merianstraße 28, 63069 Offenbach/Main (NB 0366)

### Guidelines and standards

We hereby declare that this product complies with the relevant provisions and requirements of the following guidelines and standards:

2006/42/EC (2009-10), 2000/14/EC (2006-06), 2014/30/EU (2014-02), EN 55012 (2009-07), EN 500-1 (2009-12), EN 500-4 (2011-02)

### Person responsible for technical documents

Robert Rätthsel,  
Wacker Neuson Produktion GmbH & Co. KG, Preußenstraße 41, 80809 München

München, 29.02.2016

Helmut Bauer  
Managing Director

Translation of the original Declaration of Conformity