

ARBORTECH™

ALLSAW AS175 BRICK & MORTAR SAW ALL.FG.175240.60

OWNER'S INSTRUCTION MANUAL



*Double insulation used throughout,
no provision for earthing*



Points de collecte sur www.quefairedemesdechets.fr
Privilégiez la réparation ou le don de votre appareil !



Raccolta differenziata.
Verifica le disposizioni
del tuo Comune

1. INTRODUCTION

The Arbortech AS175 Brick & Mortar Saw is designed and manufactured in Australia, using only the highest quality components and manufacturing processes.

The unique patented orbital cutting action of two reciprocating blades, allows cutting of brick, mortar and masonry faster than traditional reciprocating saws.

This cutting action also produces minimal amounts of airborne dust, offering a safe and controllable operation, with the ability to cut to a depth of 120mm (4 3/4"), cut square corners and make variable width cuts. The AS175 is ideally suited to a variety of tasks including:

- removal of mortar for tuck pointing of brick walls.
- removal of single bricks from walls.
- cutting of bricks without damage to adjacent areas or "blow-out" stitching, keying or toothing of brick walls "chasing" cuts for conduits and similar items into walls.
- cutting holes in walls or other surfaces.
- finishing corner cuts in walls.

The tool can be fitted with a range of blades to best suit different applications.

Definitions: Safety Guidelines

The definitions below describe the level of severity for each signal word. Please read the manual and pay attention to these symbols.

 **DANGER:** Indicates an imminently hazardous situation which, if not avoided, **will** result in **death or serious injury**.

 **WARNING:** Indicates a potentially hazardous situation which, if not avoided, **could** result in **death or serious injury**.

 **CAUTION:** Indicates a potentially hazardous situation which, if not avoided, **may** result in **minor or moderate injury**.

 **CAUTION:** Used without the safety alert symbol indicates a potentially hazardous situation which, if not avoided, **may** result in **property damage**.

 Denotes risk of electric shock.

2. GENERAL POWER TOOL SAFETY WARNINGS

 **WARNING:** *read all safety warnings, instructions, illustrations and specifications provided with this power tool.* Failure to follow all instructions listed below may result in electric shock, fire and/or serious injury.

Save all warnings and instructions for future reference.

The term "power tool" in the warnings refers to your mains-operated (corded) power tool.

1) Work area

- a) **Keep work area clean and well lit.** Cluttered and dark areas invite accidents.
- b) **Do not operate power tools in explosive atmospheres, such as in the presence of flammable liquids, gases or dust.** Power tools create sparks which may ignite the dust or fumes.
- c) **Keep children and bystanders away while operating a power tool.** Distractions can cause you to lose control

2) Electrical safety

- a) **Power tool plugs must match the outlet. Never modify the plug in any way. Do not use any adapter plugs with earthed (grounded) power tools.** Unmodified plugs and matching outlets will reduce risk of electric shock
- b) **Avoid body contact with earthed or grounded surfaces such as pipes, radiators, ranges and refrigerators.** There is an increased risk of electric shock if your body is earthed or grounded.
- c) **Do not expose power tools to rain or wet conditions.** Water entering a power tool will increase the risk of electric shock.
- d) **Do not abuse the cord. Never use the cord for carrying, pulling or unplugging the power tool. Keep cord away from heat, oil, sharp edges or moving parts.** Damaged or entangled cords increase the risk of electric shock.
- e) **When operating a power tool outdoors, use an extension cord suitable for outdoor use.** Use of a cord suitable for outdoor use reduces the risk of electric shock.
- f) **If operating a power tool in a damp location is unavoidable, use a residual current device (RCD) protected supply.** Use of an RCD reduces the risk of electric shock.

3) Personal safety

- a) **Stay alert, watch what you are doing and use common sense when operating a power tool. Do not use a power tool while you are tired or under the influence of drugs, alcohol or medication.** A moment of inattention while operating power tools may result in serious personal injury.
 - b) **Use personal protective equipment. Always wear eye protection.** Safety equipment such as dust mask, nonskid safety shoes, hard hat, or hearing protection used for appropriate conditions will reduce personal injuries.
 - c) **Prevent unintentional starting. Ensure the switch is in the off-position before connecting to power source and or battery pack, picking up or carrying the tool.** Carrying power tools with your finger on the switch or energising power tools that have the switch on invites accidents.
 - d) **Remove any adjusting key or wrench before turning the power tool on.** A wrench or a key left attached to a rotating part of the power tool may result in personal injury.
 - e) **Do not overreach. Keep proper footing and balance at all times.** This enables better control of the power tool in unexpected situations.
 - f) **Dress properly. Do not wear loose clothing or jewellery. Keep your hair, clothing and gloves away from moving parts.** Loose clothes, jewellery or long hair can be caught in moving parts.
 - g) **If devices are provided for the connection of dust extraction and collection facilities, ensure these are connected and properly used.** Use of these devices can reduce dust-related hazards.
 - h) **Do not let familiarity gained from frequent use of tools allow you to become complacent and ignore tool safety.** A careless action can cause severe injuries within a fraction of a second.
- d) **Store idle power tools out of the reach of children and do not allow persons unfamiliar with the power tool or these instructions to operate the power tool.** Power tools are dangerous in the hands of untrained users.
 - e) **Maintain power tools and accessories. Check for misalignment or binding of moving parts, breakage of parts and any other condition that may affect the power tools operation. If damaged, have the power tool repaired before use.** Many accidents are caused by poorly maintained power tools.
 - f) **Keep cutting tools sharp and clean.** Properly maintained cutting tools with sharp cutting edges are less likely to bind and are easier to control.
 - g) **Use the power tool, accessories and tool bits etc. in accordance with these instructions and in the manner intended for the particular type of power tool, taking into account the working conditions and the work to be performed.** Use of the power tool for operations different from those intended could result in a hazardous situation
 - h) **Keep handles and grasping surfaces dry, clean and free from oil and grease.** Slippery handles and grasping surfaces do not allow for safe handling and control of the tool in unexpected situations.

4) Power tool use and care

- a) **Do not force the power tool. Use the correct power tool for your application.** The correct power tool will do the job better and safer at the rate for which it was designed.
 - b) **Do not use the power tool if the switch does not turn it on and off.** Any power tool that cannot be controlled with the switch is dangerous and must be repaired.
 - c) **Disconnect the plug from the power source and/ or the battery pack from the power tool before making any adjustments, changing accessories, or storing power tools.** Such preventive safety measures reduce the risk of starting the power tool accidentally.
- a) **Have your power tool serviced by a qualified repair person using only identical replacement parts.** This will ensure that the safety of the power tool is maintained.

5) Service

- a) **Have your power tool serviced by a qualified repair person using only identical replacement parts.** This will ensure that the safety of the power tool is maintained.

6) Safety instructions for reciprocating saws

- a) **Hold the power tool by insulated gripping surfaces, when performing an operation where the cutting accessory may contact hidden wiring or its own cord.** Cutting accessory contacting a "live" wire may make exposed metal parts of the power tool "live" and could give the operator an electric shock.
- b) **Use clamps or another practical way to secure and support the workpiece to a stable platform.** Holding the workpiece by hand or against your body leaves it unstable and may lead to loss of control.
- c) **Do not operate the tool with any attachment other than those recommended** in this instruction manual.
- d) **Only use the tool with the correct voltage,** as specified in the tool label.
- e) **Never start a tool under load.** Start the tool before engaging the work piece.

- f) **Never start or operate the tool with fingers or other objects through the holes in the blades.**
- g) **Use care when handling blades during and after use.** The blades and some areas of the tool become hot in use.
- h) **Always ensure that before cutting there are no hazards such as electrical wiring,** pipes or insulation in the area to be cut.
- i) **Allow for resting periods** to ease the effect of the vibration of the tool. Use work gloves to minimise vibration effect on the body.
- j) **Ensure the dust extraction equipment is connected** and properly used.
- k) **The use of any accessory or attachment other than those recommended in this instruction manual may present a risk of personal injury.**
- l) **Do not force the tool.** It is designed to operate with moderate effort. Overheating of the drive system and motor can occur if the tool is overloaded.
- m) **Always operate the tool holding it with both hands.**

AS175 uses a variety of blades to suit the material being cut. Blades may also be changed to suit the required depth or length of cut.

The blades are driven via conrods and a camshaft, which is belt-driven. The belt drive designed to allow some slip in case of the blades jamming. **If excessive belt slipping occurs, re-tensioning of the belt may be required.** It is easily tightened by removing the plastic cover and is tensioned using the adjustable idler pulley (see section 7.2). Blades are mounted to the conrods using high tensile Allen™ head bolts.

A replaceable metal guard is provided to limit the maximum cutting depth and prevent the blade mounts from damaging the surface of the material being cut. Shock and vibration to the operator are reduced by a rubber-mounted top handle. The top handle is also designed for comfort when used in a variety of cutting orientations. The rubber bushes on the top handle can be replaced if they become worn or damaged.

2) Blade Description

The AS175 uses a variety of blades to cut different materials and different profiles.

General Purpose Blades use Tungsten Carbide teeth and are suited for working general masonry. General Purpose blades are designed to cut to a depth of 115mm (4 1/2").



Plunge Blades use Tungsten Carbide teeth and have a maximum cutting depth of 120mm (4 3/4"). Mortar plunge blades can cut slots of 75mm (3") in length.



Switch Box Blades use Tungsten Carbide teeth and have a maximum cutting depth of 120mm (4 3/4"). Suitable for installing small electrical switch boxes into plaster, brick/ masonry walls.



Heritage Blades Ideal for mortar removal on thin joints and heritage restoration. Depth 35mm (1 3/8"), Width 3mm (1/8")



Headjoint Blades Ideal for mortar removal on vertical joints. Depth 75mm (3"), Width 7.2mm (9/32")



Caulking Blades Ideal to remove caulking between concrete panels. E.g Tilt up, parking lots. *Available in 3 widths (1/2", 1" and 2").



XL General Purpose Blades Cutting depth up to 170mm (6 3/4") without overcutting.

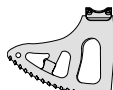

Tuckpointing Blades Used for removing the mortar between bricks in restoration work. Max. cutting Depth 35mm (1 3/8")



SYMBOLS The following symbols are used in this manual and marking of this tool	
	Class 2 Construction (Double Insulation used throughout, no provision for earthing.)
	Read instruction manual
	Wear hearing protection
	Wear eyes protection
	Wear breathing protection mask
V~	volts alternating current
A	amperes
Hz	hertz
W	watt
N ₀	no load speed
/min	reciprocations
dB	decibels
Nm	newton metres
m	metres
m/s	metres per second
mm	millimetres
kg-m	kilogram metres
ft-lb	foot pounds

3. FUNCTIONAL DESCRIPTION

1) AS175 Tool description

The AS175 is designed to cut rigid materials such as mortar, clay fired bricks, plasterboard, fibreboard. The

4. ASSEMBLY

ITEM	DESCRIPTION
1	Rear handle
2	Trigger switch
3	Lock-off lever
4	Lock on button
5	Top Handle

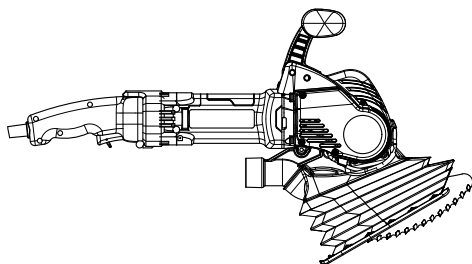
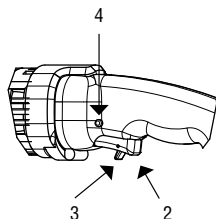
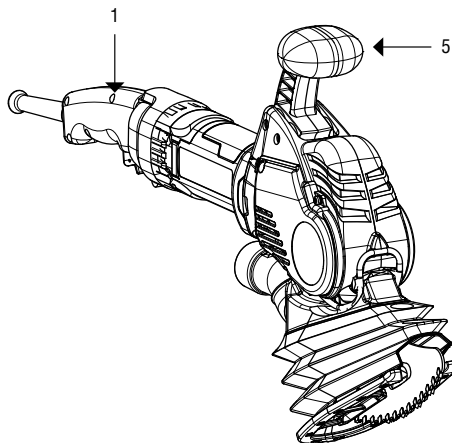

5. OPERATION

1) Setup

⚠ WARNING: It is recommended that the tool always be supplied via a residual current device with a rated residual current of 30mA or less.

The AS175 is supplied ready for operation. However in some cases the blades may need to be changed to suit the application.

Before changing blades, the guard around the blade mounts must be levered gently out of its groove at the front of the tool and swung away to give access to the cap screws. (See Fig.1)

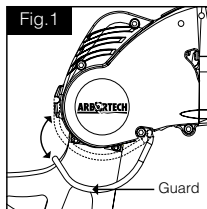

Use the "lan key" supplied to loosen and remove the cap screws securing the blades, then remove the blades as shown in Fig.2.

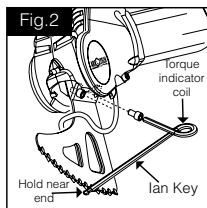

Select the correct blades for the cutting task and mount each with their cap screws. Verify that the surfaces of the blade mounts, conrod thread and screws are clean and free of grit or lubricant before fitting. Ensure the guard can be closed before fixing the blades to the conrod (See Fig.2).

NOTE: Always use matched pairs of blades. Never mix used blades with new blades. Use only the bolts supplied with the tool.

Use the "lan key" (see Fig.2), to tighten the blade mounting screws until the torque indicator coil deflects sufficiently so that the sides meet. The "lan Key" will tighten the bolts to the required 18Nm (13.2 ft lb).

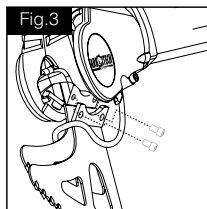

NOTE: Blades are a wearing part. In normal operation, blade life may vary with the hardness of materials cut.

⚠ CAUTION:

Do not operate the tool if the blades are loose. Operation with loose blades will severely damage the blade mount & bolts requiring repair.

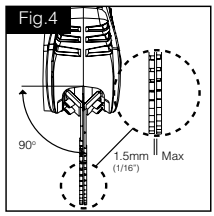

Check that the teeth of the blades are lightly contacting, or within approximately 1.5mm (1/16") of contacting each other (Fig.4).

If the gap between the blades is too large, remove and gently bend inward to adjust the gap.

Ensure that both blades are aligned vertically to the tool (See Fig.4).

⚠ CAUTION: If the blades rub against each other anywhere other than within 25mm/1" of the cutting edge, or contact force is high, it is possible to overload the tool and cause premature belt wear.

Swing the guard to its groove at the front of the tool and snap it into place. (See Fig.1)

2) Dust Extraction

The AS175 should be fitted with a Dust Boot and used with a dust extraction vacuum. The Dust Boot significantly reduces airborne dust exposure to the user and bystanders. The Dust Boot can be fitted and removed from the AS175 without tools, and with the blades mounted. To fit the Dust Boot:

1. Insert the mounted blades through the split opening on the topside of the Dust Boot

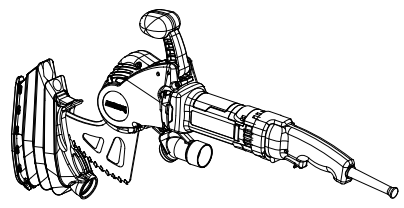
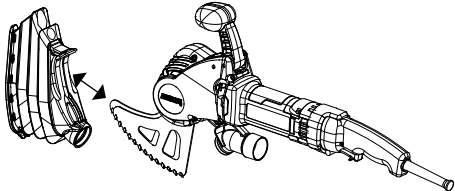

2. Pivot the Dust Boot until it engages with the dust extraction fitting and achieves a seated overlap

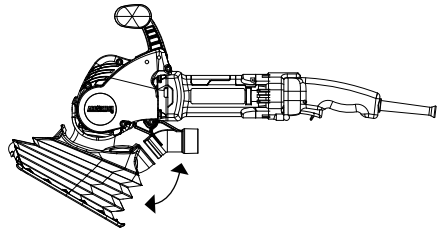

3. Pinch and fold the front tabs of Dust Boot and press underneath the guard rail.

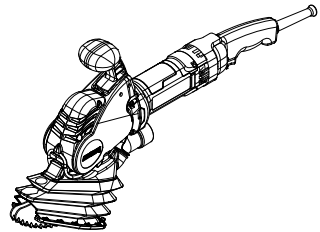

The dust extraction fitting on the underside of the AS175 is designed to accommodate standard dust extraction vacuums including a 35mm (1 3/8") diameter tapered vacuum and a 38mm (1 1/2") diameter vacuum fitting. Use an appropriate dust extraction system or vacuum intended for masonry dust.

NOTE: Failure to use the Dust Boot when cutting masonry materials will cause excessive wear of electrical components. Damage caused by dust will lead to premature failure of the motor, which will affect the warranty.

⚠ CAUTION: Verify that the vacuum machine being used has a filter system appropriate for the material being cut. Incorrect filtration can result in inadequate dust control and also possible damage to the vacuum machine.

3) Specifications

ITEM	SPECIFICATION
Cutting depth/width	120mm (4 3/4")/7.2mm (9/32") depending on blade
Weight, with cutting blades	4.3kg (9.5lb)
Dimensions without blades	610 mm (24") L 75 mm (3") W 342 mm (13.5") H
No load speed N_0	5100 rpm
Power	1400W
Electrical rating, nominal	ALL.FG.175240.40 - 230V~, 50Hz
	ALL.FG.175240.60 - 230V~, 50Hz
	ALL.FG.175110.40 - 110V~, 50Hz
Dust extraction vacuum hose interface	Suits vacuum hose with 35mm diameter internal taper fitting, or 38mm diameter external taper fitting.
Maximum mid-span belt deflection	2mm (1/16") with 15 N (1.5 kg) (3.4 lb) deflection force
Blade mount bolt torque	18 Nm (1.8 kg-m), (13.2ft-lb),
Vibration emissions GP Blade (k=1.5)	7.7m/s ²
Vibration emissions Plunge Blade (k=1.5)	5.9m/s ²
Vibration emissions Switch Blade (k=1.5)	4.8m/s ²
A- Weighted sound pressure level L_{WA}	92dB (A)
Uncertainty KpA	5dB(A)
A- Weighted sound power level L_{WA}	103 dB(A)
Uncertainty L_{WA}	5dB(A)

⚠ WARNING: The declared vibration emission level is based on measurements representing the main applications of the tool. However if the tool is used for different applications, with different accessories or poorly maintained, the vibration emission may differ. This may significantly increase the exposure level over the total working period. An estimation of the level of exposure to vibration should also take into account the times when the tool is switched off or when it is running but not actually doing the job.

This may significantly reduce the exposure level over the total working period. Identify additional safety measures to protect the operator from the effects of vibration such as: maintain the tool and the accessories, keep the hands warm, organisation of work patterns.

⚠ WARNING: The values state here only indicates the loudness emitted by this machine. Whether the operator is required to wear hearing protection cannot be determined here. This depends on how much noise reaches the operator's ear. Even though it may not be explicitly required, it is in your own interest to always wear hearing protection when operating this machine.

4) How to Use

⚠ CAUTION: During operation the AS175 may cause hand-arm vibration, which can result in fatigue or discomfort after long periods of continuous use. Vibration will increase with the hardness of material.

Do not operate the tool if discomfort is experienced, and ensure that sufficient rest periods are taken during cutting. For further information, contact the manufacturer.

Apply protective hearing, breathing, eyes and body protection as appropriate.

With the blades secured and the tool switch OFF, plug the tool into the power socket.

⚠ CAUTION: Do not block the cooling intake vents or ingest dust or debris at the rear of the motor as this may cause the motor to overheat. If working in dusty conditions, it is recommended that the vents be regularly cleaned with an air blast. (See Fig.7)

Hold the tool by both the top handle and the motor housing. (Fig.5 & 6)

To start the cut, hold the tool firmly in your hands and apply the middle of the blade cutting edge to the work, keeping in mind that the direction of cut is towards the rear of the blades.

While cutting, move the tool and blade in a slow "sawing" motion, which improves the cut rate, reduces concentrated heat build-up and evens the wear on the blades. (See Fig.8 & 9)

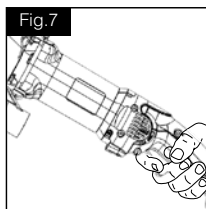
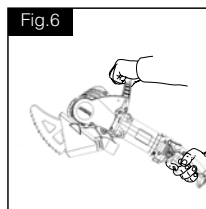
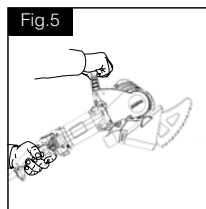

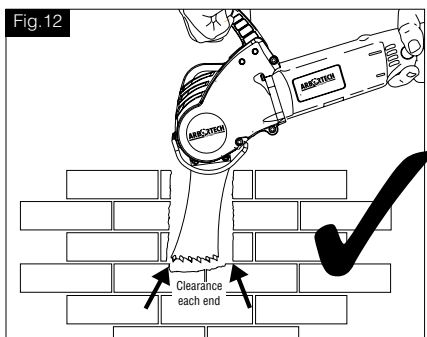
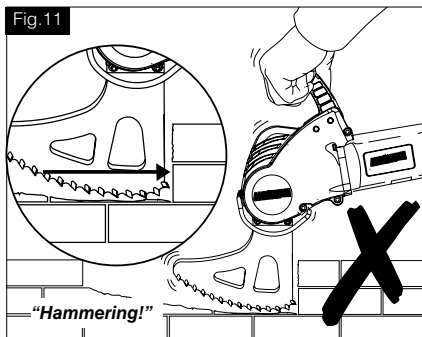
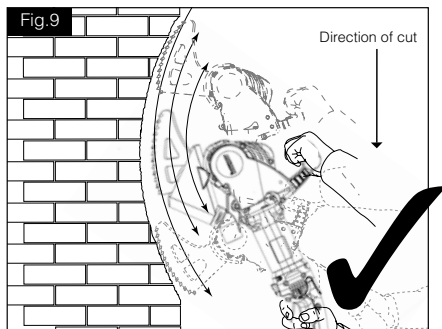
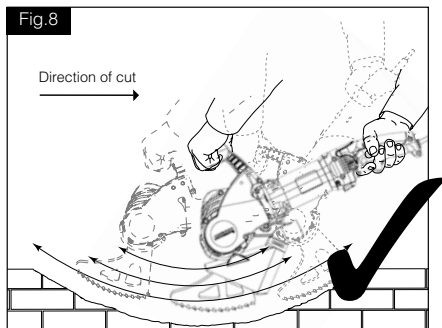

⚠ CAUTION: Do not allow the forward or rear end of the blades to hammer onto hard surfaces (shown in figs: 10,11 & 13) as this will damage the blades and tool. If unintentional hammering occurs, stop the tool or withdraw it from the cut immediately.

When using any of the blade types, avoid hammering of the ends of the blades into the ends of the cut by using a slow rocking and sweeping motion. For best performance try to ensure that the teeth are the only part of the blade in contact with the workpiece.

⚠ CAUTION: Take care when setting the tool down to avoid chipping the tungsten carbide teeth.

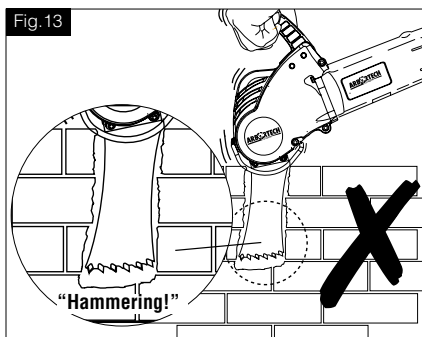
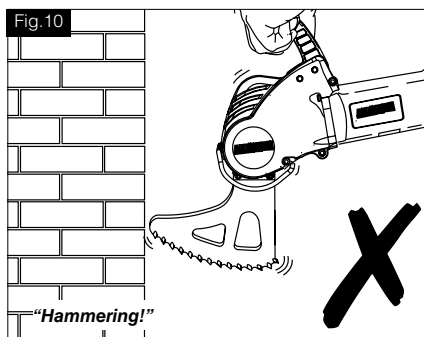

6. MAINTENANCE

⚠ WARNING: To reduce the risk of serious personal injury, turn the tool off and disconnect tool from the power source before making any adjustments or removing/installing attachments or accessories.

Before reconnecting the tool, depress and release the trigger switch to ensure that the tool is turned off.

To assure product SAFETY and RELIABILITY, repairs,

maintenance and adjustment (including brush inspection and replacement) should be performed by an ARBORTECH authorised service center. Always use identical replacement parts.

1) Motor

Cleaning

CAUTION: Blow dust and grit out of the motor and switch actuator using clean, dry compressed air is a necessary regular maintenance procedure. Dust and grit particles often accumulate on interior surfaces and can cause premature failure. Not regularly cleaning the AS175 will affect the tools warranty.

CAUTION: ALWAYS WEAR SAFETY GLASSES when using or cleaning this tool.

Never use solvents or other harsh chemicals for cleaning the non-metallic parts of the tool. Use a clean, dry cloth only.

Lubrication

ARBORTECH tools are properly lubricated at the factory and are ready for use.

Accessories

To reduce the risk of injury, only ARBORTECH accessories should be used with this product. Recommended accessories for use with your tool are available at extra cost from your local dealer or authorised service centre.

Repairs

If you need any assistance in locating any accessory, or general tool query please contact ARBORTECH. www.arbortech.com.au

Brushes

The AS175 is fitted with Auto-cut off brushes. When the brushes are worn below minimum length they stop tool operation reducing internal motor damage. Contact your local dealer or authorised service center for brush replacement.

2) Belt and Pulleys

CAUTION: The belt tension should be checked if belt slip occurs during use. Continuing to operate the tool with a loose belt may result in poor functionality or damage to the pulleys. Replacement is required if the belt cannot be sufficiently tensioned to prevent slipping.

To access these items, remove the 4 screws holding the plastic cover on the right side of the tool (see Fig.14). Inspect the belt for correct tension and signs of damage. If tensioning is required, loosen the

tension idler nut (one turn only). Slide the tension idler outward to increase the tension to the value noted in the Specifications in Section 9. and re-tighten. If belt replacement is required, loosen the tensioner idler, replace the belt and re-tension the idler as specified.

Fig.14

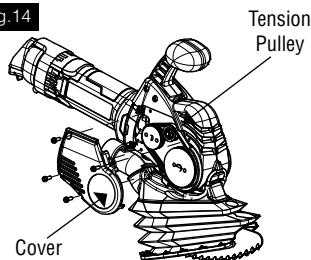

During belt tensioning or replacement a visual inspection of the pulleys should be completed, as they will wear due to excessive belt slip. Replacement may be required if the V profile grooves on the pulleys appear worn or damaged. To replace either pulley contact your ARBORTECH authorised service centre.

3) Blade Mount Bolts and Threads

The blade mount bolts should be regularly checked for correct torque (18Nm.)(13.2 ft lb). Whenever blades are changed, the bolt and conrod threads should be checked to ensure they are not worn or filled with debris. Use only genuine ARBORTECH spares and do not lubricate bolts, threads or conrod mating surfaces.

Fig.15

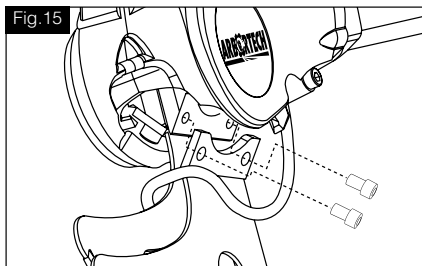

CAUTION: DO NOT operate the tool with loose blades. If blades should come loose while operating, the blade mounts and threads can become damaged, requiring significant repairs to the tool.

4) Blades and Teeth

With use, the blades will become dull and the cutting performance will decrease. Occasionally, if very hard materials are cut, or the teeth impact a hard surface at

an odd angle, teeth may become chipped or broken. The blades can still be used, but cutting performance will be reduced.

If "blueing" of the blade periphery occurs, the blades are running too hot. This occurs when the blades become worn, too much force is applied, the operator does not use sufficient sweeping motion or the material is too hard.

NOTE: Using sharp blades will improve the performance and longevity of the tool.

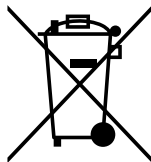

Disposal

The machine, accessories and packaging should be sorted for environmental-friendly recycling. Only for EC countries: Do not dispose of power tools into household waste! According the European Directive 2012/19/EU for Waste Electrical and Electronic Equipment and its implementation into national law, power tools that are no longer usable must be collected separately and disposed of in an environmentally correct manner.

7. WARRANTY AND SERVICE

If the supply cord of this power tool is necessary, this has to be done by the manufacturer or his agent in order to avoid a safety hazard.

For warranty repair, inspection, service and spare parts, please contact your place of purchase,

or

Contact us directly at:

ARBORTECH PTY LTD
67 WESTCHESTER ROAD, MALAGA, PERTH
WESTERN AUSTRALIA • 6090

T: +61 (0) 8 8249 1944

Fax: 08 9249 2936

www.arbortech.com.au

E: arbortech@arbortech.com.au

Declaration of Conformity

We declare under our sole responsibility that the product AS175 Brick and Mortar Saw described under "Specifications" is in conformity with the following standards or standardization documents: IEC62841 according to the provisions of the Machinery Directive 2006/42/EC

Technical file at:
Arbortech PTY LTD
67 Westchester Road
Malaga, WA 6090

Kevin Inkster
Chairman
Arbortech Pty Ltd

Sven Blinks
General Manager
Arbortech Pty Ltd

Arbortech PTY LTD
67 Westchester Road
Malaga, WA 6090



ARBORTECH PTY LTD

67 Westchester Rd, Malaga,
Perth, Western Australia 6090

Ph: +61 8 9249 1944

Fax: +61 8 9249 2936

ARBORTECH EUROPE GMBH

Esloher Str. 188,
57413 Finnentrop, Germany

(Germany) +49 2724 2880474

USA

30 Corporate Park Dr, Suite 210
Pembroke, MA 02359

(USA) Toll Free: (866) 517 7869

CANADA

120 Saunders Rd, Unit 4
Barrie, Ontario L4N 9A8

Email

arbortech@arbortech.com.au

Facebook

www.facebook.com/ArbortechTools

www.arbortechtools.com